

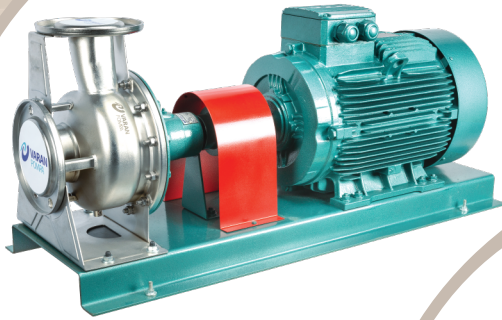

VARAN POMPA

2024-2 Product Catalog



www.varanpompa.com

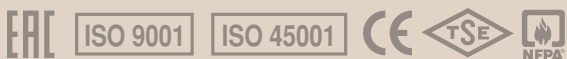



Company Profile

VARAN POMPA (Varan Tulumba San. ve Tic. Ltd. Şti.), Founded in 1975, is a sharply developing enterprise located in Çobançeşme, İstanbul, is mainly specialized in producing Water Pumps and Booster Systems reaching 800 different types with flows ranging from 1m³/h up to 1200m³/h, max. heads ranging from 12 m to 400 m.

Varan Pompa, in the past 45 years grew from small workshop into a improving factory. In 1987 The Company moved production facility to its building in Çobançeşme , İstanbul, located at 5 minutes from İstanbul Atatürk Airport and World Trade Center. By 1994, company's administrative and commercial activities moved to its building in Avclar, İstanbul.

We are proud of being the first company in Turkey to have produced peripheral pumps, vibration submersible pumps and pressure tanks for booster systems. Besides, our quality, on-time production and delivery has always been the principal of the company since the establishment.

In recent years with the participation of second generation in administration, the company has aimed to develop industrial pumps and booster systems. Meanwhile Varan Pompa has specialized in pumps and boosters attuned to the needs of clients. Furthermore the company has committed to adopt office automation systems and computer aided design to provide an advantageous platform for technical innovation.

Based on good reputation and quality, the company continues to produce CE, TSE certified pumps and TSEK certified booster systems certificated pumps coupled with CE, TSE, ISO9001 and ISO14001 certified motors complying with IEC, DIN, VDE and UL standards. Since 2009 Varan Pompa has launched fire-fighting pumps and also the models conforming to NFPA 20. Varan Pompa products are sold all over Turkey through 350 dealers and technical services provided by 100 agencies. Varan products are also exported to Iraq, Syria, Algeria, Albania, Serbia, Libia, Turkmenistan, Afghanistan, Cyprus, Kyrgyzstan, Mexico, Saudi Arabia, Georgia, England, Russia, Senegal, Azerbaijani, Bosnia&Herzegovina, Croatia, Romania, Poland, Macedonia, Czech Republic, Kazakhstan, Lithuania, Qatar, U.A.E.

Our main aim will always be your complete satisfaction and Our product selection will always be based on our clients' requirements, where we shall endeavour to offer what we believe to be the most appropriate equipment at reasonable price.

İçindekiler-Index



Paslanmaz Pompalar - Stainless Steel Pumps **05-27**

VDWK	Paslanmaz Açık Çarklı Pompalar / S/S Open Impeller Pumps	05
VBLC, VHCT, VDWB, VCA, CY,	Paslanmaz Çelik Santrifüj Pompalar / S/S Centrifugal Pumps	06-20
VCMF, VCM, VCVL, VCVF	Paslanmaz Çelik Kademeli Pompalar / S/S Multi Stage Pumps	21-27



Döküm Pompalar - Cast Iron Pumps **28-86**

QB	Sürtme Fanlı / Peripheral	28
KS, 2HCP	Çift Kademeli Monoblok / Double Stage Close-coupled	29-30
CS, VS, SP	Pis Su Pompası / Waste Water Pump	31-34
JET, SJET	Jet (Kendinden Emişli) / Jet (Self priming)	35
CAS, CES, CES-i (3000 d/d & 1500 d/d)	Salyangoz Monoblok Santrifüj / Volute Casing Close-coupled Centrifugal	36-63
ES (3000 d/d & 1500 d/d)	Salyangoz, Kaplinli Santrifüj / Volute Casing Long-coupled Centrifugal	64-83
BM, HMC, VM	Kademeli Pompalar(Noryl Fan) / Multi-Stages (Noryl Impeller)	84-86



Dalgıç/Drenaj - Submersible/Drainage Pumps **87-93**

VF	Temiz Su Drenaj Pompaları / Clean Water Drainage Pumps	88
VQDP, VQDS, VQDX	Temiz Su Drenaj Pompaları / Clean Water Drainage Pumps	90
VQD, VCUT, VQK	Pis Su Drenaj / Waste Water Drainage Pumps	91
4SD	Derin Kuyu Dalgıç / Deep Well Submersibles	92-93



Hidrofor - Booster Systems **94-109**

Paket	Hidroforlar / Packaged Booster Sets	95-98
HMC, PVM	Noryl Çarklı Dik Pompalı Hidroforlar / Vertical Pump Boosters	99-102
CVL, CVF	Paslanmaz Dik Pompalı Hidroforlar / S/S Vertical Pump Boosters	103-109



Yangın Pompa ve Hidroforları - Fire-Fighting Pumps/Booster Sets **110-112**

PVM		112
-----	--	------------

Teknik Bilgiler - Technical Information **113-122**

- Fiyatlarımıza K.D.V. dahil değildir.
 - Teslimat yeri fabrika adresimizdir.
 - Özel ambalajlar ekstra ücrete tabidir.
 - Ürünler isteğe bağlı olarak kargo veya ambarla sevk edilebilir.
 - Ürünlerimiz üretim hatalarına karşı 2 yıl garantilidir.
 - Ürünün kullanım amacı harici uygulamalar ürünü garanti kapsamı dışında bırakır.
 - Ürünler fotoğrafa göre farklılık gösterebilir
 - Yetkili Servis tarafından devreye alınmayan ürünler garanti kapsamına girmez.
- (Devreye alma işleminden önce Su ve Elektrik tesisatı kullanıcı tarafından hazırlanmış olmalıdır)

Ürünler
Products



VDWK (AÇIK ÇARKLI)
KOMPLE PASLANMAZ ÇELİK (AISI 316 / AISI 304) SANTRİFÜJ POMPALAR

STAINLESS STEEL(AISI 316/AISI 304) CENTRIFUGAL PUMPS (with open impeller)

TİP TYPE	Bağlantı Giriş x Çıkış Inlet x Outlet	MOTOR				m ³ /h	Debi (Q) - Capacity											
		HP	kW	V	A		1	3	6	16	24	28	36	44				
VDWK037	1¼" x 1"	0.5	0.37	220	2.4	Hm (mSS)	12	10	7									
VDWK037T	1¼" x 1"	0.5	0.37	380	1.1		12	10	7									
VDWK100	1.5" x 1.5"	1	0.75	220	5.2		12	11	10	6								
VDWK100T	1.5" x 1.5"	1	0.75	380	1.8		12	11	10	6								
VDWK150T	2" x 2"	1.5	1.1	380	2.6		13	12	11	9	6							
VDWK200T	2" x 2"	2	1.5	380	3.5		15	14	13	12	9	6						
VDWK300T	2.5" x 2"	3	2.2	380	5.2		18	17	16	15	15	13	10					
VDWK400T	2.5" x 2"	4	3	380	6.5		22	21	20	18	17	16	14	11				

TEKNİK ÖZELLİKLER

- Çark: Paslanmaz çelik (AISI 316)
- Partikül büyüklüğü max. Ø19 mm
- Gövde: Paslanmaz Çelik (AISI 316)
- Mil: Paslanmaz çelik (AISI 316)
- Mekanik salmastra (Karbon/Seramik/Viton)
- Çalışma sıcaklığı: +5°C ~ +90°C
- Devir Hızı: 2900d/dak.
- Koruma sınıfı: IP55
- İzalasyon sınıfı: F
- Emme derinliği: 6.5mt.

TECHNICAL DATA

- Impeller: S/S (AISI 316)
- Solids up to Ø19 mm
- Pump Body: S/S (AISI 316)
- Shaft: S/S (AISI 316)
- Non-Leakage: Mechanical seal (Carbon/Ceramic/Viton)
- Liquid Temp.: +5°C ~ +90°C
- Speed: 2900 rpm.
- Protection Class: IP55
- Insulation Class: F
- Suction lift: Max 6.5 m.

KULLANIM ALANLARI

- İçme suyu, maden suyu, saf su, Yanıcı ve Patlayıcı içermeyen temiz ve lüfatsız sıvılar.
- Max Ø19 mm partiküllü sıvılar
- Endüstriyel ve kimyasal prosesler
- Deniz suyu
- Arıtma tesisleri
- Gıda sanayi (Süt, Meyve ve Salamura Suyu vs.)
- Hafif yağlar
- Soğutma ve sirkülasyon sistemleri
- Balık çiftlikleri

APPLICATIONS

- Drinking water, mineral and pure water, Non-flammable, non-explosive liquids containing no fibre
- Convey solids up to Ø19 mm
- Industrial and chemical processes
- Sea water
- Water treatment
- Food industry (milk, fruit juices, saltwater)
- Light oil
- Chiller and circulation systems

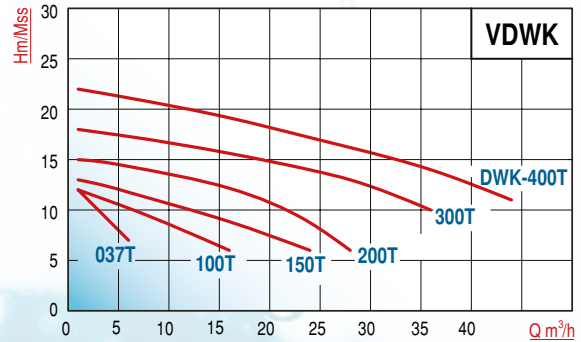
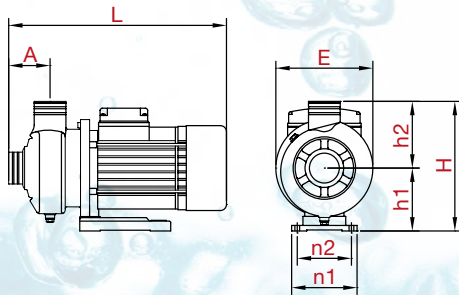

TİP TYPE	Boyutlar - Dimensions (mm)								Ağırlık - Weight
	A	L	h1	h2	H	E	n1	n2	Kg
VDWK037	50	265	84	150	177	166	125	100	7
VDWK037T	50	265	84	150	177	166	125	100	7
VDWK100T	75	335	110	124	216	172	158	120	9
VDWK150T	82	378	125	133	258	193	130	108	13
VDWK200T	82	378	125	133	258	193	130	108	15
VDWK300T	82	415	125	133	258	193	130	108	19
VDWK400T	82	432	125	133	258	193	130	108	22

VBLC

KOMPLE PASLANMAZ ÇELİK (AISI 316/AISI 304) SANTRİFÜJ POMPALAR

STAINLESS STEEL(AISI 316/AISI 304) CENTRIFUGAL PUMPS

TİP TYPE	Bağlantı Giriş x Çıkış Inlet x Outlet	MOTOR				m ³ /h	Debi (Q) - Capacity								
		HP	kW	V	A		1	2	4	6	8	11	13	18	24
VBLC70/037T	1 ¼" x 1"	0,5	0,37	380	1,1	Hm (mss)	16	15	12	9					
VBLC70/075T		1	0,75		1,8		24	23	20	16	11				
VBLC120/110T		1,5	1,1		2,6		26	25	22	21	17	12			
VBLC120/150T		2	1,5		3,5		30	29	27	24	21	15			
VBLC120/185T		2,5	1,85		4,1		35	33	30	27	24				
VBLC200/185T	1.5" x 1"	2,5	1,85	4,1	30	28	27	26	24	21	19				
VBLC370/185T	2" x 1.5"	2,5	1,85	4,1	24	23,5	23	22	21	20	18	15	9		

TEKNİK ÖZELLİKLER

- Fan: Paslanmaz çelik (AISI 316/AISI 304)
- Partikül büyüklüğü max. Ø2 mm
- Gövde: Paslanmaz Çelik (AISI 316/AISI 304)
- Mil: Paslanmaz çelik (AISI 316/AISI 304)
- Mekanik salmastra (Karbon/Seramik/Viton)
- Çalışma ısısı: +5°C ~ +90°C
- Devir Hızı: 2900d/dak.
- Koruma sınıfı: IP55
- İzalasyon sınıfı: F
- Emme derinliği: 6.5mt.

TECHNICAL DATA

- Impeller: S/S (AISI 316/AISI 304)
- Solids up to Ø2 mm
- Pump Body: S/S (AISI 316/AISI 304)
- Shaft: S/S (AISI 316/AISI 304)
- Mechanical seal (Carbon/Ceramic/Viton)
- Liquid Temp.: +5°C ~ +90°C
- Speed: 2900 rpm.
- Protection Class: IP55
- Insulation Class: F
- Suction lift: Max 6.5 m.



KULLANIM ALANLARI

- İçme suyu, maden suyu, saf su Yanıcı ve Patlayıcı içermeyen temiz ve lifsiz sıvılar.
- Max. Ø2 mm partiküllü sıvılar
- Endüstriyel ve kimyasal prosesler
- Deniz suyu
- Arıtma tesisleri
- Gıda sanayi (Süt, Meyve ve Salamura Suyu vs.)
- Hafif yağlar
- Soğutma ve sirkülasyon sistemleri

APPLICATIONS

- Drinking water, mineral and pure water, Non-flammable, non-explosive liquids containing no fibre
- Convey solids up to Ø2 mm
- Industrial and chemical processes
- Sea water
- Water treatment
- Food industry (milk, fruit juices, saltwater)
- Light oil
- Chiller and circulation systems

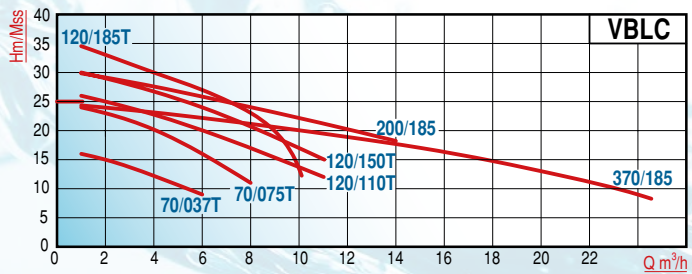
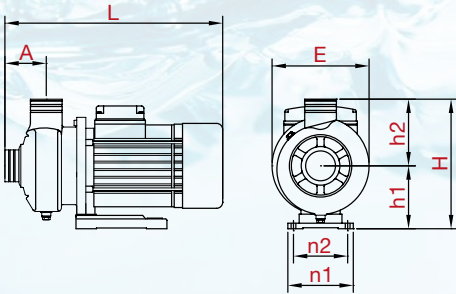

TİP TYPE	Boyutlar - Dimensions (mm)								Ağırlık - Weight
	A	L	h1	h2	H	E	n1	n2	Kg
VBLC70/037T	49	265	84	95	179	166	120	100	7,5
VBLC70/075T	49	315	110	110	220	213	160	140	10,6
VBLC120/110T	49	337	110	110	220	213	160	140	15,6
VBLC120/150T	46	373	120	120	240	234	170	150	17
VBLC120/185T	46	373	120	120	240	234	170	150	18,5
VBLC200/185T	49	354	110	112	222	213	160	140	22
VBLC370/185T	85	386	110	142	252	213	160	140	22

VHCT

KOMPLE PASLANMAZ ÇELİK (AISI 304) SANTRİFÜJ POMPALAR

STAINLESS STEEL(AISI 304) CENTRIFUGAL PUMPS

TİP TYPE	Bağlantı Giriş x Çıkış Inlet x Outlet	MOTOR				m ³ /h	Debi (Q) - Capacity							
		HP	kW	V	A		1,2	2,4	3,6	4,8	6	7,2	8,4	10,8
VHCT-18S-E	1 ¼" x 1"	0,5	0,37	380	1,1	16	14	12	9,5	7	4			
VHCT-20S-E		0,75	0,55		1,8	20,5	19	17	14	11	8			
VHCT-26S-E		1,0	0,75		2,6	24	22	19,5	17	14	11	8		
VHCT-30S-E		1,5	1,1		3,5	28	26	24	22	20	18	15,5	10	6
VHCT-33S-E		2,0	1,5		4,1		29	27	25	23	21	19	13	9,5

TEKNİK ÖZELLİKLER

- Fan: Paslanmaz çelik (AISI 304)
- Partikül büyüklüğü max. Ø2 mm
- Gövde: Paslanmaz Çelik (AISI 304)
- Mil: Paslanmaz çelik (AISI 304)
- Mekanik salmastra: Ø16 (Karbon/Seramik/NBR)
- Çalışma sıcaklığı: +5°C ~ +70°C
- Devir Hızı: 2900d/dak.
- Koruma sınıfı: IP44
- İzalasyon sınıfı: B
- Emme derinliği: 6.5mt.

TECHNICAL DATA

- Impeller: S/S (AISI 304)
- Solids up to Ø2 mm
- Pump Body: S/S (AISI 304)
- Shaft: S/S (AISI 304)
- Mechanical seal: Ø16 (Carbon/Ceramic/NBR)
- Liquid Temp.: +5°C ~ +70°C
- Speed: 2900 rpm.
- Protection Class: IP44
- Insulation Class: B
- Suction lift: Max 6.5 m.



KULLANIM ALANLARI

- İçme suyu, saf su
- Yanıcı ve Patlayıcı içermeyen Temiz ve lifsiz sıvılar.
- Max. Ø2 mm partiküllü sıvılar

APPLICATIONS

- Drinking water, pure water,
- Non-flammable, non-explosive liquids containing no fibre
- Convey solids up to Ø2 mm

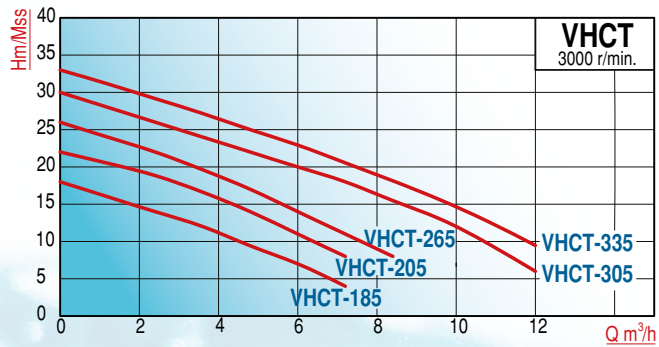
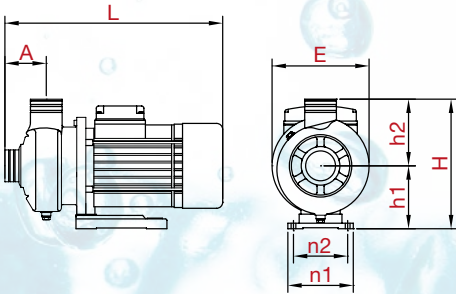

TİP TYPE	Boyutlar - Dimensions (mm)								Ağırlık - Weight
	A	L	h1	h2	H	E	n1	n2	Kg
VHCT-18S	45	310	112	110	222	212	160	120	8
VHCT-20S	45	310	112	110	222	212	160	120	9
VHCT-26S	50	310	110	114	224	214	160	120	9,7
VHCT-30S	54	370	120	132	252	235	182	140	16
VHCT-33S	54	370	120	132	252	235	182	140	17,3

VDWB

KOMPLE PASLANMAZ ÇELİK (AISI 316/AISI 304) SANTRİFÜJ POMPALAR

STAINLESS STEEL(AISI 316/AISI 304) CENTRIFUGAL PUMPS

TİP TYPE	Bağlantı Giriş x Çıkış Inlet x Outlet	MOTOR				m ³ /h	Debi (Q) - Capacity				
		HP	kW	V	A		5	10	20	30	40
VDWB250/100T	1.5" x 1.5"	1,33	1	380		Hm (mSS)	17	15	8		
VDWB300/1.1T	2" x 2"	1.5	1.1	380	2.6		20	18	12	6	
VDWB300/1.5T		2	1.5	380	3.5		25	22	16	10	
VDWB500/2.2T		3	2.2	380	5.2		25	23	20	16	10
VDWB500/3.0T		4	3	380	6.5		28	26	23	19	12

TEKNİK ÖZELLİKLER

- Çark: Paslanmaz çelik (AISI 316/AISI 304)
- Partikül büyüklüğü max. Ø4 mm
- Gövde: Paslanmaz Çelik (AISI 316/AISI 304)
- Mil: Paslanmaz çelik (AISI 316/AISI 304)
- Mekanik salmastra (Karbon/Seramik/Viton)
- Çalışma sıcaklığı: +5°C ~ +90°C
- Devir Hızı: 2900d/dak.
- Koruma sınıfı: IP55
- İzalasyon sınıfı: F
- Emme derinliği: 6.5mt.

TECHNICAL DATA

- Impeller: S/S (AISI 316/AISI 304)
- Solids up to Ø4 mm
- Pump Body: S/S (AISI 316/AISI 304)
- Shaft: S/S (AISI 316/AISI 304)
- Non-Leakage: Mechanical seal (Carbon/Ceramic/Viton)
- Liquid Temp.: +5°C ~ +90°C
- Speed: 2900 rpm.
- Protection Class: IP55
- Insulation Class: F
- Suction lift: Max 6.5 m.

KULLANIM ALANLARI

- İçme suyu, maden suyu, saf su Yanıcı ve Patlayıcı içermeyen temiz ve lıfısız sıvılar.
- Max. Ø4 mm partiküllü sıvılar
- Endüstriyel ve kimyasal prosesler
- Deniz suyu
- Arıtma tesisleri
- Gıda sanayi (Süt, Meyve ve Salamura Suyu vs.)
- Hafif yağlar
- Soğutma ve sirkülasyon sistemleri

APPLICATIONS

- Drinking water, mineral and pure water, Non-flammable, non-explosive liquids containing no fibre
- Convey solids up to Ø4 mm
- Industrial and chemical processes
- Sea water
- Water treatment
- Food industry (milk, fruit juices, saltwater)
- Light oil
- Chiller and circulation systems

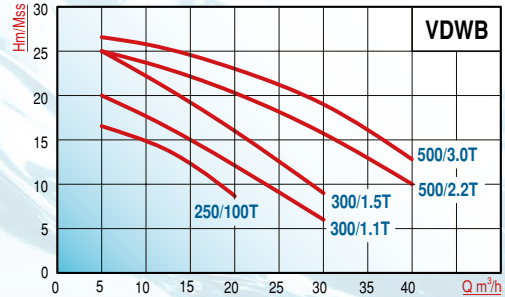
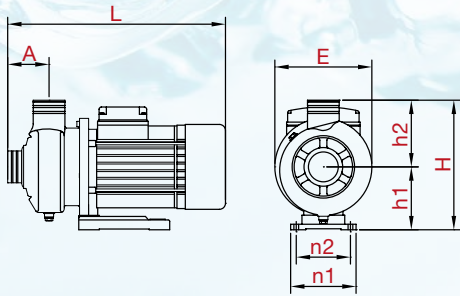

TİP TYPE	Boyutlar - Dimensions (mm)								Ağırlık - Weight
	A	L	h1	h2	H	E	n1	n2	Kg
VDWB250/100T	75	340	110	120	230	170	160	120	10
VDWB300/1.1T	82	378	125	133	258	193	130	108	13
VDWB300/1.5T	82	378	125	133	258	193	130	108	15
VDWB500/2.2T	82	415	125	133	258	193	130	108	19
VDWB500/3.0T	82	432	125	133	258	193	130	108	22

VCA

KOMPLE PASLANMAZ ÇELİK (AISI 316/AISI 304) SANTRİFÜJ POMPALAR

STAINLESS STEEL(AISI 316/AISI 304) CENTRIFUGAL PUMPS

TİP TYPE	Bağlantı Giriş x Çıkış Inlet x Outlet	MOTOR				m ³ /h	Debi (Q) - VCApacity							
		HP	kW	V	A									
							3	6	9	12	15	18	20	22
VCA50-32-160/1.1T	2" x 1¼"	1,5	1,1	380	2,6	Hm (mSS)	22	20	19	16	15	12	10	7
VCA50-32-160/1.5T		2	1,5		3,5		26	24	23	21	18	15	12	10
VCA50-32-160/2.2T		3	2,2		4,9		31	29	28	26	24	22	20	16
VCA50-32-200/3.0T		4	3		6,3		38	37	35	34	32	30	28	26
VCA50-32-200/4.0T		5,5	4		9,6		52	50	48	45	43	41	39	30
VCA50-32-200/5.5T		7,5	5,5		11,1		62	60	58	54	52	47	42	37
VCA50-32-200/7.5T		10	7,5		14,9		67	65	64	63	61	59	57	55

TİP TYPE	Bağlantı Giriş x Çıkış Inlet x Outlet	MOTOR				m ³ /h	Debi (Q) - VCApacity							
		HP	kW	V	A									
							5	10	15	20	25	30	35	40
VCA65-40-125/1.5T	2,5"x1,5"	2	1,5	380	3,5	Hm (mSS)	20	19	18	16	13	10,5		
VCA65-40-125/2.2T		3	2,2		4,9		27	26	24	22	20	17	14	
VCA65-40-125/3.0T		4	3		6,3		31	30	29	27	25	22	18	
VCA65-40-160/4.0T		5,5	4		9,6		39	38	37	34	31	28	24	19
VCA65-40-200/5.5T		7,5	5,5		11,1		47	46	45	44	41	38	34	30
VCA65-40-200/7.5T		10	7,5		14,9		53	52	51	50	48	45	42	38
VCA65-40-200/11T		15	11		21,2		70	69	68	67	66	65	64	60

TİP TYPE	Bağlantı Giriş x Çıkış Inlet x Outlet	MOTOR				m ³ /h	Debi (Q) - VCApacity							
		HP	kW	V	A									
							5	10	20	30	40	50	60	70
VCA65-50-125/3.0T	2.5" x 2"	4	3	380	6,3	Hm (mSS)	27	26	23	20	16	10		
VCA65-50-125/4.0T		5,5	4		9,6		28	27	26	24	21	16		
VCA65-50-160/5.5T		7,5	5,5		11,1		35	34	33	31	28	24	20	
VCA65-50-200/7.5T		10	7,5		14,9		42	41	40	38	36	32	27	
VCA65-50-200/9.2T		12	9,2		18,3		52	51	50	49	45	41	37	
VCA65-50-200/11T		15	11		21,2		57	56	55	53	51	48	42	30
VCA65-50-200/15T		20	15		28,6		69	68	67	65	62	60	57	50
VCA65-50-200/18.5T		25	18,5		34,7		73	72	71	70	68	66	64	59

TEKNİK ÖZELLİKLER

- Çark: Paslanmaz çelik (AISI 316)
- Partikül büyüklüğü max.04-09 mm
- Gövde: Paslanmaz çelik (AISI 316)
- Mil: Paslanmaz çelik (AISI 316)
- Mekanik salmastra (Karbon/Seramik/Viton) Ø25-Ø30
- Çalışma sıcaklığı: +5°C ~ +90°C
- Devir Hızı: 2900d/dak.
- Koruma sınıfı: IP55
- İzalasyon sınıfı: F
- Emme derinliği: 6.5mt.

TECHNICAL DATA

- Impeller: S/S (AISI 316)
- Solids up to Ø4 mm
- Pump Body: S/S (AISI 316)
- Shaft: S/S (AISI 316)
- Non-Leakage: Mechanical seal (Carbon/Ceramic/Viton) Ø25-Ø30
- Liquid Temp.: +5°C ~ +90°C
- Speed: 2900 rpm.
- Protection Class: IP55
- Insulation Class: F
- Suction lift: Max 6.5 m.

KULLANIM ALANLARI

- İçme suyu, maden suyu, saf su
- Yanıcı ve Patlayıcı içermeyen temiz ve lifsiz sıvılar.
- Max. Ø4 mm partiküllü sıvılar
- Endüstriyel ve kimyasal prosesler
- Deniz suyu
- Arıtma tesisleri
- Gıda sanayi (Süt, Meyve ve Salamura Suyu vs.)
- Hafif yağlar
- Soğutma ve sirkülasyon sistemleri

APPLICATIONS

- Drinking water, mineral and pure water,
- Non-flammable, non-explosive liquids containing no fibre
- Convey solids up to Ø4 mm
- Industrial and chemical processes
- Sea water
- Water treatment
- Food industry (milk, fruit juices, saltwater)
- Light oil
- Chiller and circulation systems



VCA

KOMPLE PASLANMAZ ÇELİK (AISI 316/AISI 304) SANTRİFÜJ POMPALAR

STAINLESS STEEL(AISI 316/AISI 304) CENTRIFUGAL PUMPS

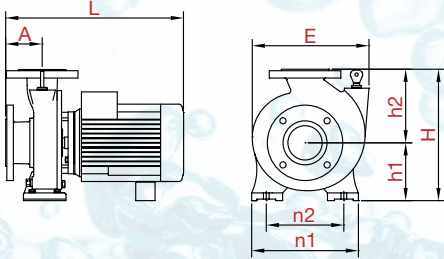
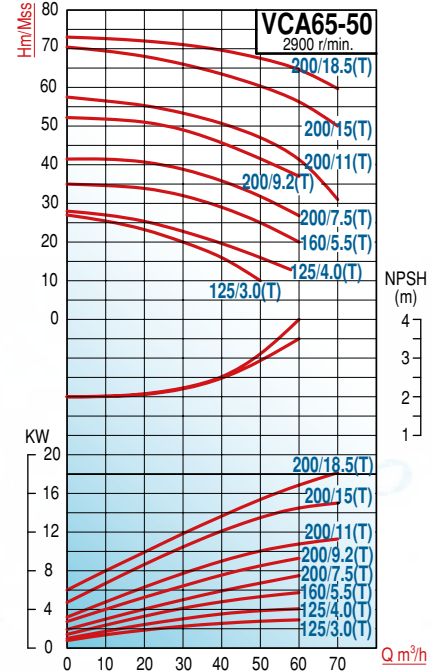
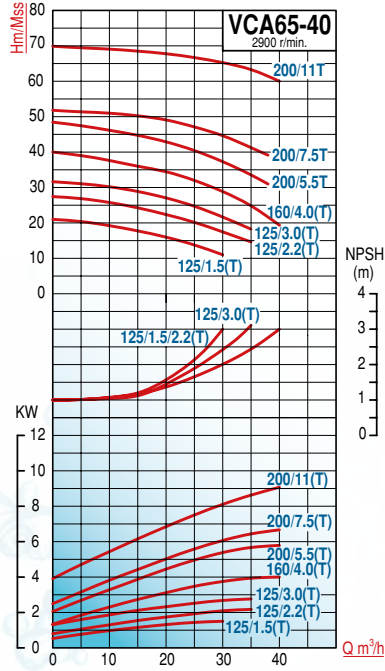
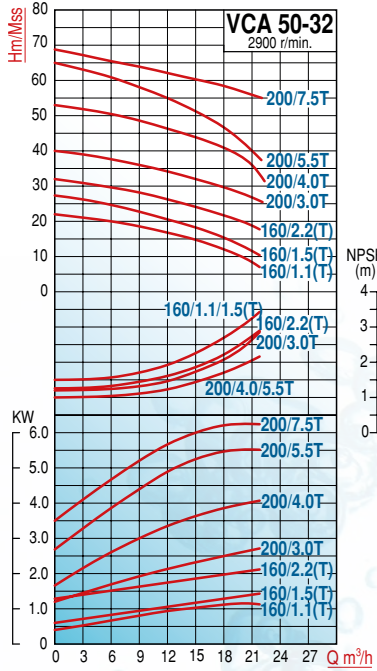

TIP TYPE	Boyutlar - Dimensions (mm)								Ağırlık - Weight
	A	L	h1	h2	H	E	n1	n2	Kg
VCA50-32-160/1.1T	80	395	112	143	255	215	190	160	18
VCA50-32-160/1.5T	80	395	112	143	255	215	190	160	19
VCA50-32-160/2.2T	80	435	112	143	255	215	190	160	24
VCA50-32-200/3.0T	80	452	160	180	340	296	240	190	34
VCA50-32-200/4.0T	80	503	160	180	340	296	240	190	41
VCA50-32-200/5.5T	80	532	160	180	340	296	240	190	53
VCA50-32-200/7.5T	80	560	160	180	350	320	240	190	63
VCA65-40-125/1.5T	80	437	112	143	340	214	190	160	20
VCA65-40-125/2.2T	80	437	112	143	340	214	190	160	25
VCA65-40-125/3.0T	80	460	132	160	292	214	240	190	31
VCA65-40-160/4.0T	80	488	132	142	274	255	240	190	39
VCA65-40-200/5.5T	100	554	160	200	360	360	264	212	53
VCA65-40-200/7.5T	100	593	160	200	360	300	264	212	64
VCA65-40-200/11T	100	623	160	200	360	300	264	212	81
VCA 65-50-125/3.0T	80	465	132	160	292	255	240	190	31
VCA 65-50-125/4.0T	80	495	132	160	292	260	190	240	39
VCA 65-50-160/5.5T	100	495	132	160	292	260	212	264	53
VCA 65-50-200/7.5T	100	580	160	200	360	300	212	264	64
VCA 65-50-200/9.2T	100	580	160	200	360	300	212	264	72
VCA 65-50-200/11T	100	610	160	200	360	300	212	264	81
VCA 65-50-200/15T	100	640	160	200	360	300	264	212	95
VCA 65-50-200/18.5T	100	720	160	200	360	300	264	212	132

VCA

KOMPLE PASLANMAZ ÇELİK (AISI 316/AISI 304) SANTRİFÜJ POMPALAR

STAINLESS STEEL(AISI 316/AISI 304) CENTRIFUGAL PUMPS

TİP TYPE	Bağlantı Giriş x Çıkış Inlet x Outlet	MOTOR				m ³ /h	Debi (Q) - VCApacity							
		HP	kW	V	A									
		40	50	60	80		100	110	120	130				
VCA80-65-125/4.0T	3" x 2½"	5,5	4	380	9,6	Hm (mSS)	19	18	17	13	9			
VCA80-65-125/5.5T		7,5	5,5		11,1		22	21	20	18	15	13	10	
VCA80-65-125/7.5T		10	7,5		14,9		27	26	25	23	20	18	15	
VCA80-65-125/9.2T		12	9,2		18,3		30	29	28	27	25	23	22	19
VCA80-65-160/11T		15	11		21,2		36	35	34	32	29	27	25	22
VCA80-65-160/15T		20	15		28,6		44	43	42	39	37	36	34	32
VCA80-65-200/18.5T		25	18,5		34,7		53	52	51	49	47	45	44	41
VCA80-65-200/22T		30	22		41		60	59	58	56	54	53	51	49
VCA80-65-200/30T		40	30		55,4		72	72	71	69	67	66	65	63

TİP TYPE	Bağlantı Giriş x Çıkış Inlet x Outlet	MOTOR				m ³ /h	Debi (Q) - VCApacity							
		HP	kW	V	A									
		60	80	120	140		160	180	190	200				
VCA100-80-160/11T	4"x3"	15	11	380	21,2	Hm (mSS)	26	25	22	20	17	14	11	
VCA100-80-160/15T		20	15		28,6		35	33	29	27	24	21	20	18
VCA100-80-160/18.5T		25	18,5		34,7		38	37	35	33	30	27	25	22
VCA100-80-200/22T		30	22		41		46	44	40	38	35	31	29	26
VCA100-80-200/30T		40	30		55,4		57	56	53	50	47	44	42	39
VCA100-80-200/37T		50	37		67,9		66	65	61	59	56	53	51	48

TEKNİK ÖZELLİKLER

- Çark: Paslanmaz çelik (AISI 316)
- Partikül büyüklüğü max. Ø18 mm
- Gövde: Paslanmaz Çelik (AISI 316)
- Mil: Paslanmaz çelik (AISI 316)
- Mekanik salmastra (Karbon/Seramik/Viton) Ø25
- Çalışma ısısı: +5°C ~ +90°C
- Devir Hızı: 2900d/dak.
- Koruma sınıfı: IP55
- İzalasyon sınıfı: F
- Emme derinliği: 6.5mt.

TECHNICAL DATA

- Impeller: S/S (AISI 316)
- Solids up to Ø4 mm
- Pump Body: S/S (AISI 316)
- Shaft: S/S (AISI 316)
- Non-Leakage: Mechanical seal (Carbon/Ceramic/Viton) Ø25
- Liquid Temp.: +5°C ~ +90°C
- Speed: 2900 rpm.
- Protection Class: IP55
- Insulation Class: F
- Suction lift: Max 6.5 m.

KULLANIM ALANLARI

- İçme suyu, maden suyu, saf su
- Yanıcı ve Patlayıcı içermeyen temiz ve lifsiz sıvılar.
- Max. Ø4 mm partiküllü sıvılar
- Endüstriyel ve kimyasal prosesler
- Deniz suyu
- Arıtma tesisleri
- Gıda sanayi (Süt, Meyve ve Salamura Suyu vs.)
- Hafif yağlar
- Soğutma ve sirkülasyon sistemleri

APPLICATIONS

- Drinking water, mineral and pure water, Non-flammable, non-explosive liquids containing no fibre
- Convey solids up to Ø4 mm
- Industrial and chemical processes
- Sea water
- Water treatment
- Food industry (milk, fruit juices, saltwater)
- Light oil
- Chiller and circulation systems



VCA

KOMPLE PASLANMAZ ÇELİK (AISI 316/AISI 304) SANTRİFÜJ POMPALAR

STAINLESS STEEL(AISI 316/AISI 304) CENTRIFUGAL PUMPS

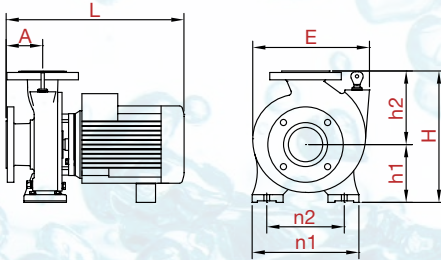
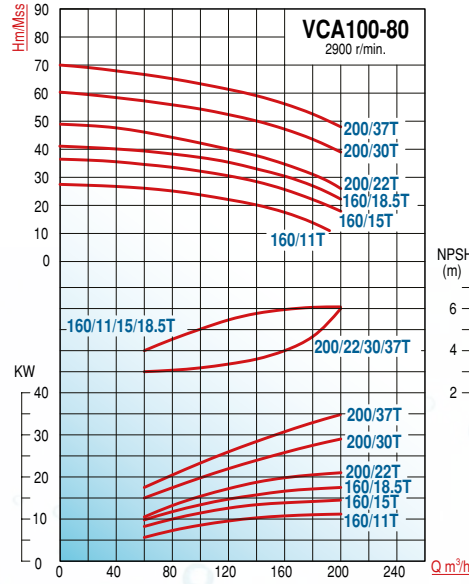
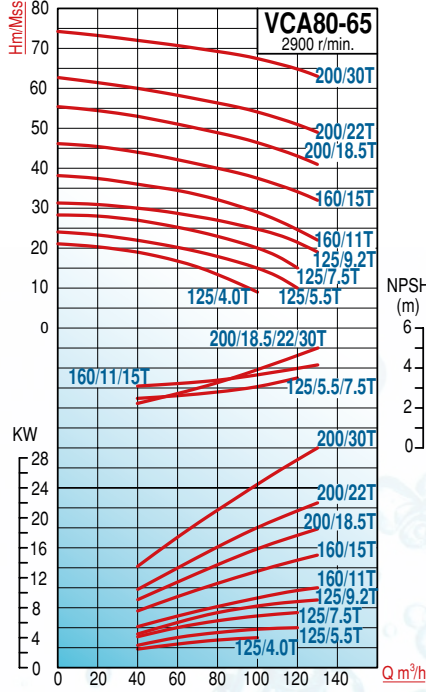

TİP TYPE	Boyutlar - Dimensions (mm)								Ağırlık - Weight
	A	L	h1	h2	H	E	n1	n2	Kg
VCA80-65-125/4.0T	100	514	160	180	340	256	250	212	40
VCA80-65-125/5.5T	100	548	160	180	340	256	250	212	55
VCA80-65-125/7.5T	100	548	160	180	340	256	250	212	70
VCA80-65-125/9.2T	100	548	160	180	340	256	250	212	78
VCA80-65-160/11T	100	620	160	200	360	300	250	212	90
VCA80-65-160/15T	100	670	160	200	360	300	250	212	92
VCA80-65-200/18.5T	100	620	180	200	360	300	250	212	100
VCA80-65-200/22T	100	776	180	225	405	300	290	250	210
VCA80-65-200/30T	100	844	180	225	405	300	290	212	280
VCA100-80-160/11T	125	669	180	225	405	256	290	250	91
VCA100-80-160/15T	125	711	180	225	405	256	290	250	102
VCA100-80-160/18.5T	125	769	180	225	405	256	290	250	142
VCA100-80-200/22T	125	811	180	250	430	300	320	280	212
VCA100-80-200/30T	100	880	200	250	450	300	320	280	282
VCA100-80-200/37T	125	880	180	225	405	300	320	280	300

CY (3000 d/d)

KOMPLE PASLANMAZ ÇELİK (AISI 316) KAPLINLI SANTRİFÜJ POMPALAR

STAINLESS STEEL(AISI 316) CENTRIFUGAL PUMPS

TİP TYPE	Bağlantı Giriş x Çıkış Inlet x Outlet	MOTOR				m ³ /h	Debi (Q) - Capacity													
		HP	kW	V	A		3	6	9	12	15	18	20	22						
CY50-32-160/1.1T	2" x 1¼"	1,5	1,1	380	2,4	Hm (mSS)	22	20	19	16	15	12	10	7						
CY50-32-160/1.5T		2	1,5		3,2		26	24	23	21	18	15	12	10						
CY50-32-160/2.2T		3	2,2		4,7		31	29	28	26	24	22	20	16						
CY50-32-200/3.0T		4	3		6,3		38	37	35	34	32	30	28	26						
CY50-32-200/4.0T		5,5	4		9,6		52	50	48	45	43	41	39	30						
CY50-32-200/5.5T		7,5	5,5		11,1		62	60	58	54	52	47	42	37						

TİP TYPE	Bağlantı Giriş x Çıkış Inlet x Outlet	MOTOR				m ³ /h	Debi (Q) - Capacity												
		HP	kW	V	A		5	10	15	20	25	30	35	40					
CY65-40-125/1.5T	2½"x1½"	2	1,5	380	3,2	Hm (mSS)	20	19	18	16	13	10,5							
CY65-40-125/2.2T		3	2,2	380	4,7		27	26	24	22	20	17	14						
CY65-40-125/3.0T		4	3	380	6,3		31	30	29	27	25	22	18						
CY65-40-160/4.0T		5,5	4	380	9,6		39	38	37	34	31	28	24	19					
CY65-40-200/5.5T		7,5	5,5	380	11,1		47	46	45	44	41	38	34	30					
CY65-40-200/7.5T		10	7,5	380	14,9		53	52	51	50	48	45	42	38					
CY65-40-200/11T		15	11	380	21,2		70	69	68	67	66	65	64	60					
CY65-40-200/15T																			

TİP TYPE	Bağlantı Giriş x Çıkış Inlet x Outlet	MOTOR				m ³ /h	Debi (Q) - Capacity												
		HP	kW	V	A		5	10	20	30	40	50	60	70					
CY65-50-125/3.0T	2½" x 2"	4	3	380	6,3	Hm (mSS)	27	26	23	20	16	10							
CY65-50-125/4.0T		5,5	4	380	9,6		28	27	26	24	21	16							
CY65-50-160/5.5T		7,5	5,5	380	11,1		35	34	33	31	28	24	20						
CY65-50-200/7.5T		10	7,5	380	14,9		42	41	40	38	36	32	27						
CY65-50-200/11T		15	11	380	21,2		57	56	55	53	51	48	42	30					
CY65-50-200/15T		20	15	380	28,6		69	68	67	65	62	60	57	50					
CY65-50-200/18.5T		25	18,5	380	34,7		73	72	71	70	68	66	64	59					

TEKNİK ÖZELLİKLER

- Çark: Paslanmaz çelik (AISI 316)
- Partikül büyüklüğü max.04-09mm
- Gövde: Paslanmaz Çelik (AISI 316)
- Mil: Paslanmaz çelik (AISI 316)
- Mekanik salmastra (Karbon/Seramik/Viton) Ø25
- Çalışma ısısı: +5°C ~ +90°C
- Devir Hızı: 2900d/dak.
- Koruma sınıfı: IP55
- İzalasyon sınıfı: F
- Emme derinliği: 6.5mt.

TECHNICAL DATA

- Impeller: S/S (AISI 316)
- Solids up to Ø4 mm
- Pump Body: S/S (AISI 316)
- Shaft: S/S (AISI 316)
- Non-Leakage: Mechanical seal (Carbon/Ceramic/Viton) Ø25
- Liquid Temp.: +5°C ~ +90°C
- Speed: 2900 rpm.
- Protection Class: IP55
- Insulation Class: F
- Suction lift: Max 6.5 m.

KULLANIM ALANLARI

- İçme suyu, maden suyu, saf su Yanıcı ve Patlayıcı içermeyen temiz ve lıfızlı sıvılar.
- Max. 04 mm partiküllü sıvılar
- Endüstriyel ve kimyasal prosesler
- Deniz suyu
- Arıtma tesisleri
- Gıda sanayi (Süt, Meyve ve Salamura Suyu vs.)
- Hafif yağlar
- Soğutma ve sirkülasyon sistemleri

APPLICATIONS

- Drinking water, mineral and pure water,
- Non-flammable, non-explosive liquids containing no fibre
- Convey solids up to Ø4 mm
- Industrial and chemical processes
- Sea water
- Water treatment
- Food industry (milk, fruit juices, saltwater)
- Light oil
- Chiller and circulation systems

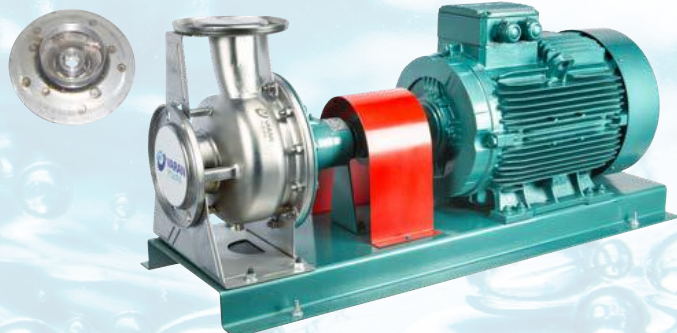

CY (3000 d/d)

KOMPLE PASLANMAZ ÇELİK (AISI 316)KAPLINLİ SANTRİFÜJ POMPALAR

STAINLESS STEEL(AISI 316) CENTRIFUGAL PUMPS

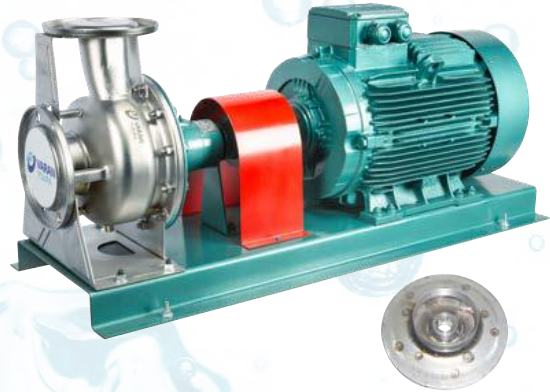
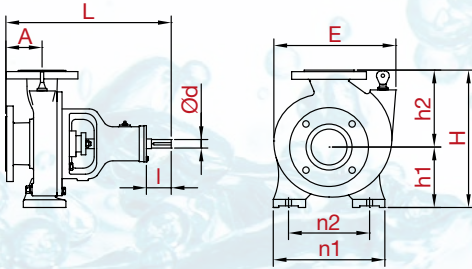
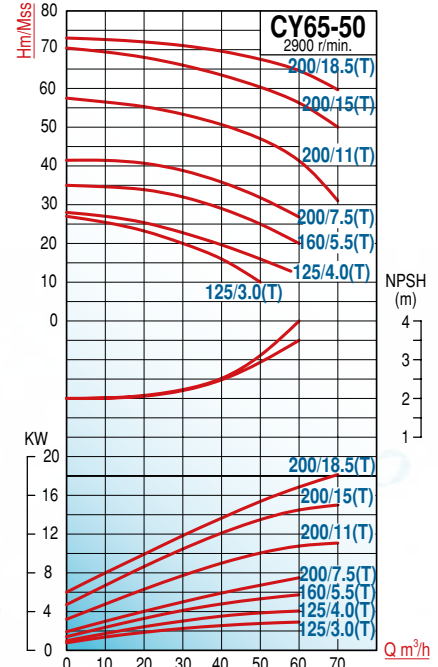
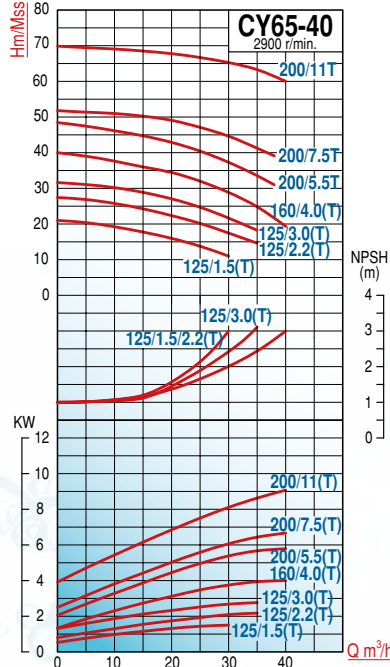
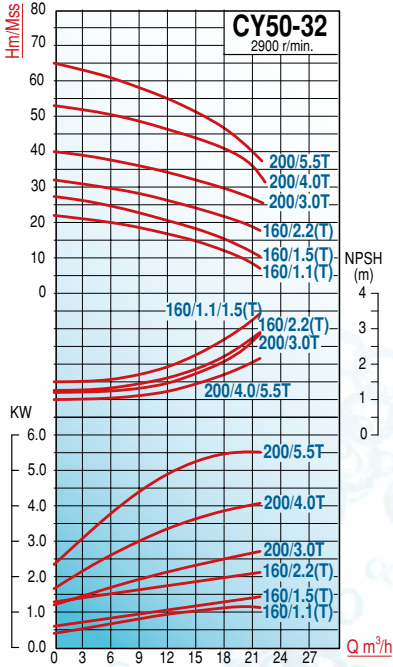

TİP TYPE	Boyutlar - Dimensions (mm)										Tek Pompa	
	A	L	h1	h2	H	E	n1	n2	i	d	Ağırlık - Weight (kg)	
CY50-32-160/1.1T	80	359	112	143	246	210	190	160	71	22	18	
CY50-32-160/1.5T	80	359	112	143	246	210	190	160	71	22	18	
CY50-32-160/2.2T	80	359	112	143	246	210	190	160	71	22	18	
CY50-32-200/3.0T	80	353	160	180	279	300	240	190	62	22	27	
CY50-32-200/4.0T	80	353	160	180	302	300	240	190	62	22	27	
CY50-32-200/5.5T	80	353	160	180	322	300	240	190	62	22	27	
CY65-40-125/1.5T	80	359	112	143	255	210	190	160	71	22	18	
CY65-40-125/2.2T	80	359	112	143	255	210	190	160	71	22	18	
CY65-40-125/3.0T	80	352	132	160	292	250	240	190	71	22	22	
CY65-40-200/4.0T	80	352	132	142	292	250	240	190	71	22	22	
CY65-40-200/5.5T	100	375	160	200	322	300	264	212	62	22	28	
CY65-40-200/7.5T	100	375	160	200	322	300	264	212	62	22	28	
CY65-40-200/11T	100	375	160	200	339	300	264	212	62	22	28	
CY65-50-125/3.0T	80	352	132	160	295	260	240	190	71	22	23	
CY65-50-125/4.0T	80	352	132	160	295	260	240	190	71	22	23	
CY65-50-160/5.5T	100	375	160	200	360	300	264	212	62	22	28	
CY65-50-200/7.5T	100	375	160	200	360	300	264	212	62	22	28	
CY65-50-200/11T	100	375	160	200	360	300	264	212	62	22	28	
CY65-50-200/15T	100	375	160	200	360	300	264	212	62	22	28	
CY65-50-200/18.5T	100	375	160	200	360	350	264	212	62	22	28	

CY (3000 d/d)

KOMPLE PASLANMAZ ÇELİK (AISI 316) KAPLINLI SANTRİFÜJ POMPALAR

STAINLESS STEEL(AISI 316) CENTRIFUGAL PUMPS

TİP TYPE	Bağlantı Giriş x Çıkış Inlet x Outlet	MOTOR				m ³ /h Hm (mSS)	Debi (Q) - Capacity							
		HP	kW	V	A		40	50	60	80	100	110	120	130
		CY80-65-125/4.0T	5,5	4	380		9,6	19	18	17	13	9		
CY80-65-125/5.5T	7,5	5,5	380	11,1	22	21	20	18	15	13	10			
CY80-65-125/7.5T	10	7,5	380	14,9	27	26	25	23	20	18	15			
CY80-65-125/9.2T	12	9,2	380	18,3	30	29	28	27	25	23	22	19		
CY80-65-160/11T	15	11	380	21,2	36	35	34	32	29	27	25	22		
CY80-65-160/15T	20	15	380	28,6	44	43	42	39	37	36	34	32		
CY80-65-200/18.5T	25	18,5	380	34,7	53	52	51	49	47	45	44	41		
CY80-65-200/22T	30	22	380	41	60	59	58	56	54	53	51	49		
CY80-65-200/30T	40	30	380	55,4	72	72	71	69	67	66	65	63		

Flanşlar hariçtir. Takım fiyatı: 140 USD

TİP TYPE	Bağlantı Giriş x Çıkış Inlet x Outlet	MOTOR				m ³ /h Hm (mSS)	Debi (Q) - Capacity							
		HP	kW	V	A		60	80	120	140	160	180	190	200
		CY100-80-160/11T	15	11	380		21,6	26	25	22	20	17	14	11
CY100-80-160/15T	20,0	15	380	28,6	35	33	29	27	24	21	20	18		
CY100-80-160/18.5T	25,0	18,5	380	34,7	38	37	35	33	30	27	25	22		
CY100-80-200/22T	30	22	380	41	46	44	40	38	35	31	29	26		
CY100-80-200/30T	40	30	380	55,4	57	56	53	50	47	44	42	39		
CY100-80-200/37T	50	37	380	68	66	65	61	59	56	53	51	48		

Flanşlar hariçtir. Takım fiyatı: 160 USD

TEKNİK ÖZELLİKLER

- Çark: Paslanmaz çelik (AISI 316)
- Partikül büyüklüğü max. Ø18 mm
- Gövde: Paslanmaz Çelik (AISI 316)
- Mil: Paslanmaz çelik (AISI 316)
- Mekanik salmastra (Karbon/Seramik/Viton) Ø25 & Ø30
- Çalışma ısısı: +5°C ~ +90°C
- Devir Hızı: 2900d/dak.
- Koruma sınıfı: IP55
- İzalasyon sınıfı: F
- Emme derinliği: 6.5mt.

TECHNICAL DATA

- Impeller: S/S (AISI 316)
- Solids up to Ø4 mm
- Pump Body: S/S (AISI 316)
- Shaft: S/S (AISI 316)
- Non-Leakage: Mechanical seal (Carbon/Ceramic/Viton) Ø25 & Ø30
- Liquid Temp.: +5°C ~ +90°C
- Speed: 2900 rpm.
- Protection Class: IP55
- Insulation Class: F
- Suction lift: Max 6.5 m.

APPLICATIONS

- Drinking water, mineral and pure water, Non-flammable, non-explosive liquids containing no fibre
- Convey solids up to Ø4 mm
- Industrial and chemical processes
- Sea water
- Water treatment
- Food industry (milk, fruit juices, saltwater)
- Light oil
- Chiller and circulation systems

KULLANIM ALANLARI

- İçme suyu, maden suyu, saf su
- Yanıcı ve Patlayıcı içermeyen temiz ve lifsiz sıvılar.
- Max. Ø4 mm partiküllü sıvılar
- Endüstriyel ve kimyasal prosesler
- Deniz suyu
- Arıtma tesisleri
- Gıda sanayi (Süt, Meyve ve Salamura Suyu vs.)
- Hafif yağlar
- Soğutma ve sirkülasyon sistemleri

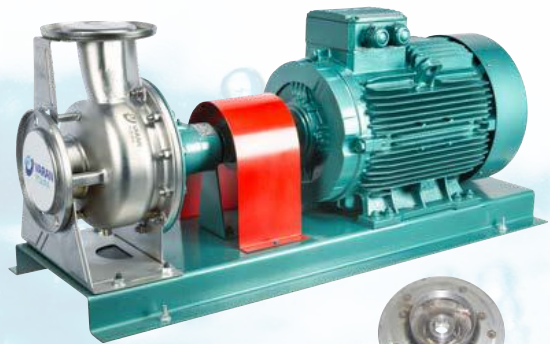

CY (3000 d/d)

KOMPLE PASLANMAZ ÇELİK (AISI 316) KAPLINLİ SANTRİFÜJ POMPALAR

STAINLESS STEEL(AISI 316) CENTRIFUGAL PUMPS

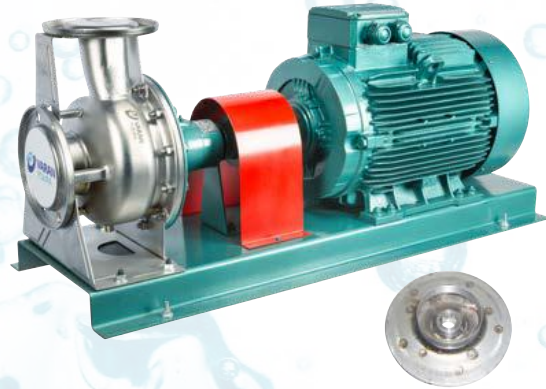
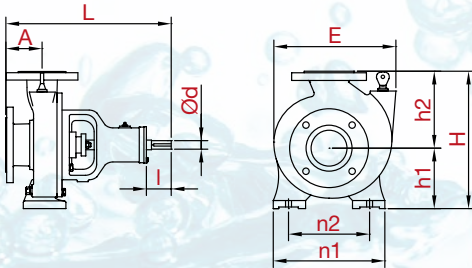
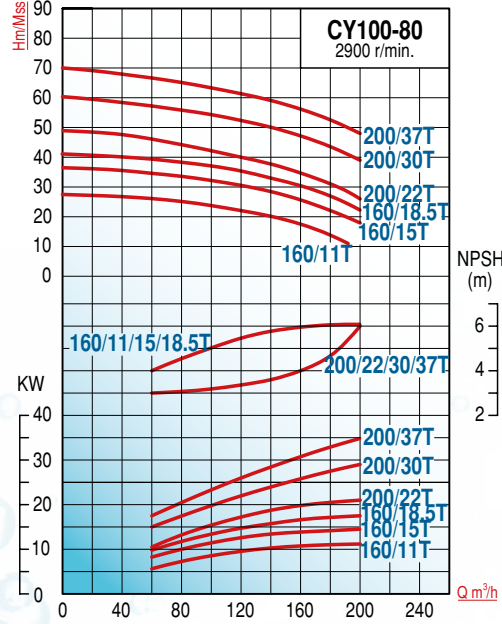
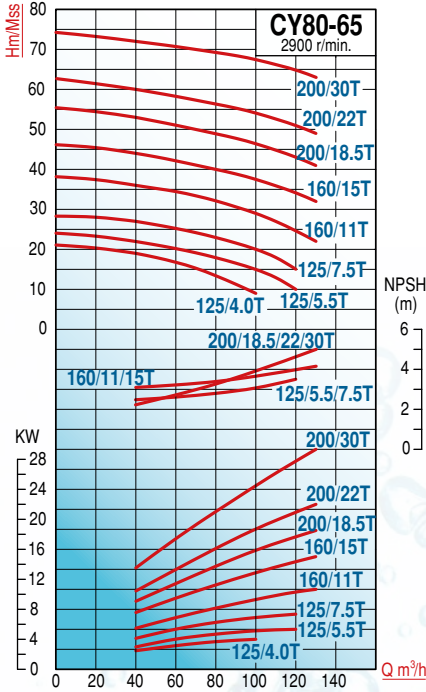

TİP TYPE	Boyutlar - Dimensions (mm)										Tek Pompa	
	A	L	h1	h2	H	E	n1	n2	ı	d	Ağırlık - Weight (kg)	
CY80-65-125/4.0T	100	377	160	180	340	256	250	212	71	22	24	
CY80-65-125/5.5T	100	377	160	180	340	256	250	212	71	22	24	
CY80-65-125/7.5T	100	377	160	180	340	256	250	212	71	22	24	
CY80-65-160/11T	100	377	160	200	360	300	250	212	62	22	29	
CY80-65-160/15T	100	377	160	200	360	300	250	212	62	22	29	
CY80-65-200/18.5T	100	376	180	225	405	300	290	250	62	22	29	
CY80-65-200/22T	100	376	180	225	405	300	290	250	62	22	29	
CY80-65-200/30T	100	376	180	225	405	300	290	250	62	22	30	
CY100-80-160/11T	125	407	180	225	405	256	290	250	71	22	26	
CY100-80-160/15T	125	407	180	225	405	256	290	250	71	22	26	
CY100-80-160/18.5T	125	407	180	225	405	256	290	250	71	22	26	
CY100-80-200/22T	125	412	180	250	430	300	320	280	62	22	31	
CY100-80-200/30T	125	412	200	250	450	300	320	280	62	22	31	
CY100-80-200/37T	125	412	200	250	450	300	320	280	62	22	31	

CY (1500 d/d)

KOMPLE PASLANMAZ ÇELİK (AISI 316) KAPLINLİ SANTRİFÜJ POMPALAR

STAINLESS STEEL(AISI 316) CENTRIFUGAL PUMPS

TİP TYPE	Bağlantı Giriş x Çıkış Inlet x Outlet	MOTOR				m ³ /h Hm (mss)	Debi (Q) - Capacity							
		HP	kW	V	A		3	4	5	6	7	8	9	10
	CY50-32-160/0.25T	2" x 1¼"	0,33	0,25	380		0,85	5,5	5,2	5	4,7	4,3	3,9	3,5
CY50-32-160/0.37T	0,5		0,37	380	1	7	6,4	6,3	6,2	5,9	5,7	5	4,2	
CY50-32-200/0.37T	0,5		0,37	380	1	8,7	8,5	8,2	8	7,7	7,4	7	6,5	
CY50-32-200/0.55T	0,75		0,55	380	1,45	12	11,8	11,4	11	10,5	10	9,4	8,4	
CY50-32-200/0.75T	1		0,75	380	1,95	17,3	17	16,7	16,5	15,6	15	14,8	13,6	

TİP TYPE	Bağlantı Giriş x Çıkış Inlet x Outlet	MOTOR				m ³ /h Hm (mss)	Debi (Q) - Capacity							
		HP	kW	V	A		6	8	10	12	15	18	20	21
	CY65-40-125/0.37T	2½" x 1½"	0,5	0,37	380		1	4,8	4,5	4,3	4	3,4	2,6	2
CY65-40-125/0.37T	0,5		0,37	380	1	6,3	6,1	5,8	5,5	4,9	4,2	3,6	3,4	
CY65-40-125/0.55T	0,75		0,55	380	1,45	7,1	6,5	6,4	6,1	5,5	4,8	4,3	4,1	
CY65-40-160/0.55T	0,75		0,55	380	1,45	8,5	8,1	7,8	7,5	6,9	6,2	5,6	5,4	
CY65-40-200/1,1T	1,5		1,1	380	2,6	11	10,7	10,4	10,1	9,6	9	8,6	8,3	
CY65-40-200/1.1T	1,5		1,1	380	2,6	12,7	12,5	12,2	11,9	11,2	10,4	9,7	9,4	
CY65-40-200/1.5T	2		1,5	380	3,4	17,8	17,5	17,2	16,9	16,2	15,3	14,6	14,2	

TİP TYPE	Bağlantı Giriş x Çıkış Inlet x Outlet	MOTOR				m ³ /h Hm (mss)	Debi (Q) - Capacity							
		HP	kW	V	A		12	15	18	21	24	30	33	36
	CY65-50-125/0.55T	2½" x 2"	0,75	0,55	380		1,45	4,9	4,7	4,4	4,2	3,8	3	2,6
CY65-50-125/0.55T	0,75		0,55	380	1,45	5,8	5,6	5,4	5,2	4,9	4,1	3,7	3,2	
CY65-50-160/1.1T	1,5		1,1	380	2,6	7,7	7,5	7,2	6,9	6,5	5,6	5	4,5	
CY65-50-200/1.1T	1,5		1,1	380	2,6	9	8,8	8,5	8,2	7,8	6,9	6,3	5,8	
CY65-50-200/1.5T	2		1,5	380	3,4	12,1	11,8	11,4	11	10,5	9,3	8,6	8	
CY65-50-200/1.5T	2		1,5	380	3,4	13	12,7	12,3	11,9	11,5	10,5	9,8	9,1	
CY65-50-200/2.2T	3		2,2	380	4,85	17,7	17,5	17,2	16,8	16,4	15,4	14,8	14	
CY65-50-200/3.0T	4		3	380	6,42	18,6	18	17,5	17,1	16,7	16	15,6	15	

TEKNİK ÖZELLİKLER

- Çark: Paslanmaz çelik (AISI 316)
- Partikül büyüklüğü max. Ø4 mm
- Gövde: Paslanmaz Çelik (AISI 316)
- Mil: Paslanmaz çelik (AISI 316)
- Mekanik salmastra (Karbon/Seramik/Viton) Ø25
- Çalışma ısısı: +5°C ~ +90°C
- Devir Hızı: 2900d/dak.
- Koruma sınıfı: IP55
- İzalasyon sınıfı: F
- Emme derinliği: 6.5mt.

TECHNICAL DATA

- Impeller: S/S (AISI 316)
- Solids up to Ø4 mm
- Pump Body: S/S (AISI 316)
- Shaft: S/S (AISI 316)
- Non-Leakage: Mechanical seal (Carbon/Ceramic/Viton) Ø25
- Liquid Temp.: +5°C ~ +90°C
- Speed: 2900 rpm.
- Protection Class: IP55
- Insulation Class: F
- Suction lift: Max 6.5 m.

KULLANIM ALANLARI

- İçme suyu, maden suyu, saf su
- Yanıcı ve Patlayıcı içermeyen temiz ve lifsiz sıvılar.
- Max. Ø4 mm partiküllü sıvılar
- Endüstriyel ve kimyasal prosesler
- Deniz suyu
- Arıtma tesisleri
- Gıda sanayi (Süt, Meyve ve Salamura Suyu vs.)
- Hafif yağlar
- Soğutma ve sirkülasyon sistemleri

APPLICATIONS

- Drinking water, mineral and pure water, Non-flammable, non-explosive liquids containing no fibre
- Convey solids up to Ø4 mm
- Industrial and chemical processes
- Sea water
- Water treatment
- Food industry (milk, fruit juices, saltwater)
- Light oil
- Chiller and circulation systems

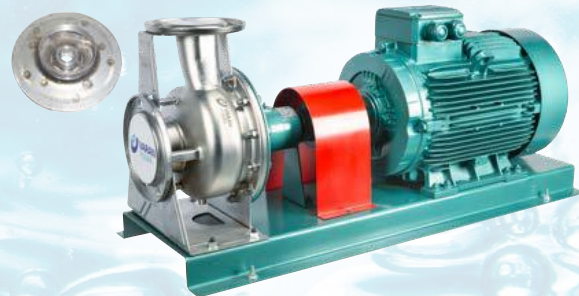

CY (1500 d/d)

KOMPLE PASLANMAZ ÇELİK (AISI 316) KAPLINLİ SANTRİFÜJ POMPALAR

STAINLESS STEEL(AISI 316) CENTRIFUGAL PUMPS

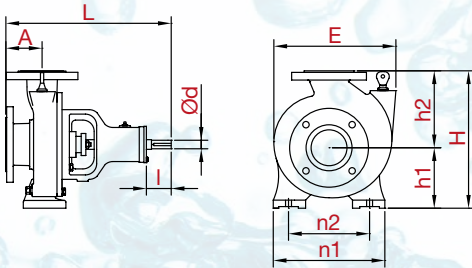
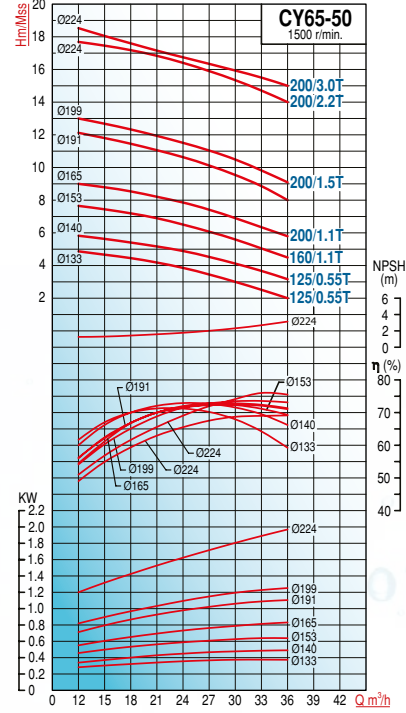
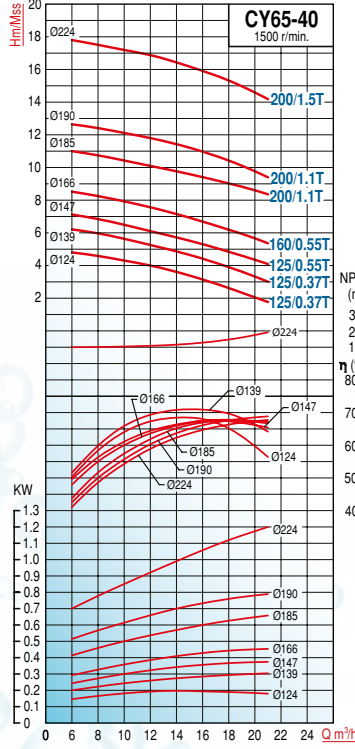
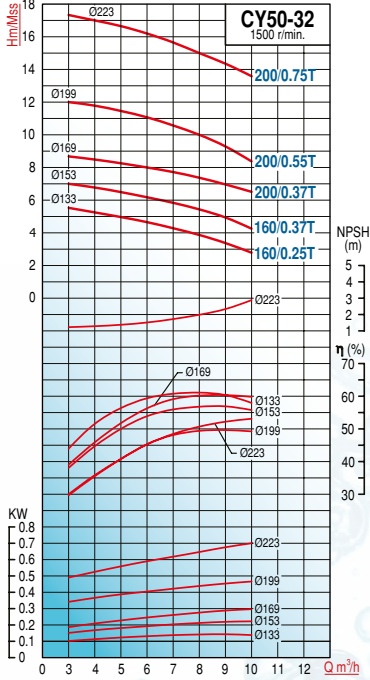

TİP TYPE	Boyutlar - Dimensions (mm)										Tek Pompa	
	A	L	h1	h2	H	E	n1	n2	i	d	Ağırlık - Weight (kg)	
CY50-32-160/0.25T	80	359	112	143	246	210	190	160	71	22	18	
CY50-32-160/0.37T	80	359	112	143	246	210	190	160	71	22	18	
CY50-32-200/0.37T	80	353	160	180	279	300	240	190	62	22	27	
CY50-32-200/0.55T	80	353	160	180	302	300	240	190	62	22	27	
CY50-32-200/0.75T	80	353	160	180	322	300	240	190	62	22	27	
CY65-40-125/0.37T	80	359	112	143	255	210	190	160	71	22	18	
CY65-40-125/0.37T	80	359	112	143	255	210	190	160	71	22	18	
CY65-40-125/0.55T	80	352	132	160	292	250	240	190	71	22	22	
CY65-40-160/0.55T	80	352	132	142	292	250	240	190	71	22	22	
CY65-40-200/1.1T	100	375	160	200	322	300	264	212	62	22	28	
CY65-40-200/1.1T	100	375	160	200	322	300	264	212	62	22	28	
CY65-40-200/1.5T	100	375	160	200	339	300	264	212	62	22	28	
CY65-50-125/0.55T	80	352	132	160	295	260	240	190	71	22	23	
CY65-50-125/0.55T	80	352	132	160	295	260	240	190	71	22	23	
CY65-50-160/1.1T	100	375	160	200	360	300	264	212	62	22	28	
CY65-50-200/1.1T	100	375	160	200	360	300	264	212	62	22	28	
CY65-50-200/1.5T	100	375	160	200	360	300	264	212	62	22	28	
CY65-50-200/1.5T	100	375	160	200	360	300	264	212	62	22	28	
CY65-50-200/2.2T	100	375	160	200	360	300	264	212	62	22	28	
CY65-50-200/3.0T	100	375	160	200	360	350	264	212	62	22	28	

CY (1500 d/d)

KOMPLE PASLANMAZ ÇELİK (AISI 316) KAPLINLI SANTRİFÜJ POMPALAR

STAINLESS STEEL(AISI 316) CENTRIFUGAL PUMPS

TİP TYPE	Bağlantı		MOTOR				m ³ /h	Debi (Q) - Capacity							
	Giriş x Çıkış		HP	kW	V	A		21	24	30	39	48	57	66	72
	Inlet x Outlet														
CY80-65-125/0.55T	3" x 2½"		0,75	0,55	380	1,45	4,6	4,4	4	3,2	2,3	1,4			
CY80-65-125/0.75T			1	0,75		1,95	5,8	5,7	5,2	4,4	3,5	2,5			
CY80-65-125/1.1T			1,5	1,1		2,6	7	6,7	6,3	5,4	4,5	3,5			
CY80-65-125/1.1T			1,5	1,1		2,6	8,1	7,9	7,4	6,3	5,7	4,6			
CY80-65-160/1.5T			2	1,5		3,4	9,2	9	8,5	7,7	6,7	5,7	4,5		
CY80-65-160/2.2T			3	2,2		4,85	11,3	11,1	10,6	9,8	8,8	7,6	6,4	5,5	
CY80-65-200/3.0T			4	3		6,42	12,4	12,4	11,6	10,6	9,5	8,4	7,2	6,3	
CY80-65-200/4.0T			5,5	4		8,2	15	14,8	14,5	14	12,9	11,6	10,1	9	
CY80-65-200/5.5T			7,5	5,5		11,2	18	17,8	17,6	17,1	16,5	15,7	14,5	12	

TİP TYPE	Bağlantı		MOTOR				m ³ /h	Debi (Q) - Capacity							
	Giriş x Çıkış		HP	kW	V	A		30	36	60	72	84	96	100	108
	Inlet x Outlet														
CY100-80-160/1.5T	4" x 3"		2	1,5	380	3,4	7	6,8	5,7	5	4,2	3,4	3	2,4	
CY100-80-160/2.2T			3	2,2		4,85	8,7	8,4	7,3	6,7	6	5,2	4,9	4,2	
CY100-80-160/3.0T			4	3		6,42	9,5	9,3	8,3	7,8	7,1	6,2	5,9	5,2	
CY100-80-200/3.0T			4	3		6,42	12,4	12,1	10,7	9,7	8,6	7,3	6,9	5,9	
CY100-80-200/5.5T			7,5	5,5		11,2	14,5	14,3	13,2	12,2	11,2	10,1	9,5	8,8	
CY100-80-200/5.5T			7,5	5,5		11,2	16,5	16,1	14,4	13,5	12,5	11,3	10,9	9,9	

TEKNİK ÖZELLİKLER

- Çark: Paslanmaz çelik (AISI 316)
- Partikül büyüklüğü max. Ø18 mm
- Gövde: Paslanmaz Çelik (AISI 316)
- Mil: Paslanmaz çelik (AISI 316)
- Mekanik salmastra (Karbon/Seramik/Viton) Ø25-Ø30
- Çalışma sıcaklığı: +5°C ~ +90°C
- Devir Hızı: 2900d/dak.
- Koruma sınıfı: IP55
- İzalasyon sınıfı: F
- Emme derinliği: 6.5mt.

TECHNICAL DATA

- Impeller: S/S (AISI 316)
- Solids up to Ø4 mm
- Pump Body: S/S (AISI 316)
- Shaft: S/S (AISI 316)
- Non-Leakage: Mechanical seal (Carbon/Ceramic/Viton) Ø25-Ø30
- Liquid Temp.: +5°C ~ +90°C
- Speed: 2900 rpm.
- Protection Class: IP55
- Insulation Class: F
- Suction lift: Max 6.5 m.

KULLANIM ALANLARI

- İçme suyu, maden suyu, saf su
- Yanıcı ve Patlayıcı içermeyen temiz ve lifsiz sıvılar.
- Max. Ø4 mm partiküllü sıvılar
- Endüstriyel ve kimyasal prosesler
- Deniz suyu
- Arıtma tesisleri
- Gıda sanayi (Süt, Meyve ve Salamura Suyu vs.)
- Hafif yağlar
- Soğutma ve sirkülasyon sistemleri

APPLICATIONS

- Drinking water, mineral and pure water, Non-flammable, non-explosive liquids containing no fibre
- Convey solids up to Ø4 mm
- Industrial and chemical processes
- Sea water
- Water treatment
- Food industry (milk, fruit juices, saltwater)
- Light oil
- Chiller and circulation systems

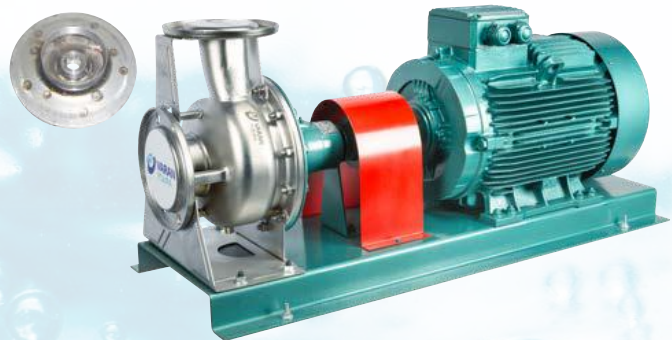

CY (1500 d/d)

KOMPLE PASLANMAZ ÇELİK (AISI 316) KAPLINLİ SANTRİFÜJ POMPALAR

STAINLESS STEEL(AISI 316) CENTRIFUGAL PUMPS

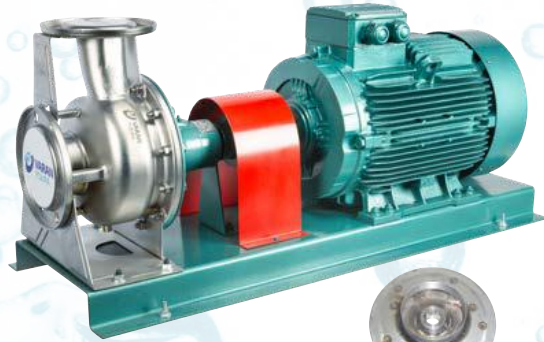
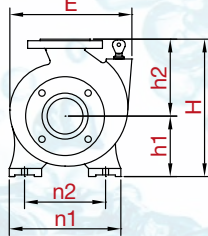
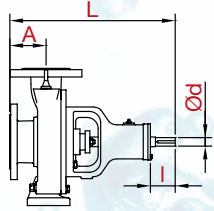
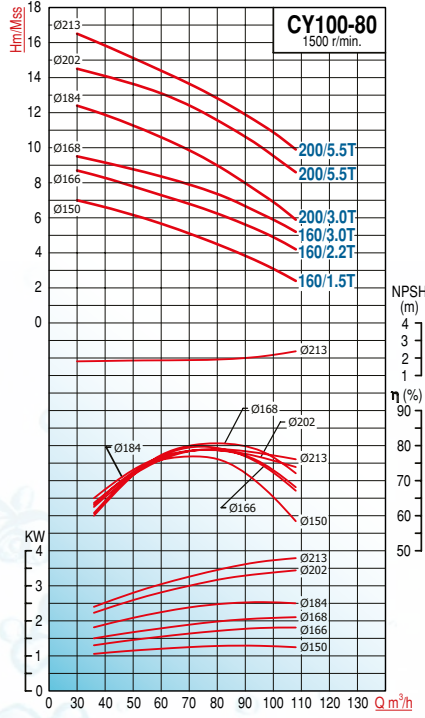
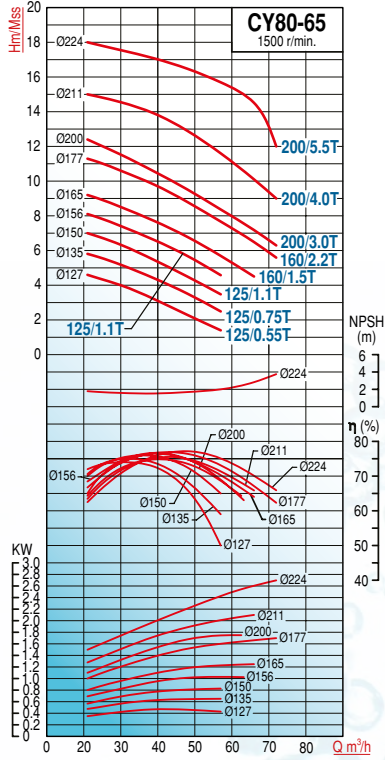

TİP TYPE	Boyutlar - Dimensions (mm)										Tek Pompa
	A	L	h1	h2	H	E	n1	n2	ı	d	Ağırlık - Weight (kg)
CY80-65-125/0.55T	100	377	160	180	340	256	250	212	71	22	24
CY80-65-125/0.75T	100	377	160	180	340	256	250	212	71	22	24
CY80-65-125/1.1T	100	377	160	180	340	256	250	212	71	22	24
CY80-65-125/1.1T	100	377	160	180	340	256	250	212	71	22	24
CY80-65-160/1.5T	100	377	160	200	360	300	250	212	62	22	29
CY80-65-160/2.2T	100	377	160	200	360	300	250	212	62	22	29
CY80-65-200/3.0T	100	376	180	225	405	300	290	250	62	22	29
CY80-65-200/4.0T	100	376	180	225	405	300	290	250	62	22	29
CY80-65-200/5.5T	100	376	180	225	405	300	290	250	62	22	30
CY100-80-160/1.5T	125	407	180	225	405	256	290	250	71	22	26
CY100-80-160/2.2T	125	407	180	225	405	256	290	250	71	22	26
CY100-80-160/3.0T	125	407	180	225	405	256	290	250	71	22	26
CY100-80-200/3.0T	125	412	180	250	430	300	320	280	62	22	31
CY100-80-200/5.5T	125	412	200	250	450	300	320	280	62	22	31
CY100-80-200/5.5T	125	412	200	250	450	300	320	280	62	22	31

VCMF

KOMPLE PASLANMAZ ÇELİK (AISI 316) KADEMELİ POMPALAR

STAINLESS STEEL(AISI 316) MULTI-STAGE PUMPS

TİP TYPE	Bağlantı Giriş x Çıkış Inlet x Outlet	MOTOR		MOTOR				Kademe Stage	m ³ /h	Debi (Q) - Capacity							
				HP	kW	V				A		2	5	7	10	15	30
						Mono	Tri			Mono	Tri						
VCMF4-40	1 1/4" x 1"	1	0.75	220	380	5.2	1.9	4	Hm (mSS)	38	25	16	3				
VCMF8-20	1.5" x 1.5"	1.5	1.1	220	380	6.2	2.4	2		34	28	23	15				
VCMF12-25	1.5" x 1.5"	3	2.2	220	380	14	5.2	3		50	48	45	40	30			
VCMF16-30	2" x 2"	3	2.2	-	380	-	5.2	3		40	39	38	36	31	9		

TEKNİK ÖZELLİKLER

- Çark: Paslanmaz Çelik (AISI 316)
- Difüzör: Paslanmaz Çelik (AISI 316)
- Gövde: Paslanmaz Çelik (AISI 316)
- Mil: Paslanmaz Çelik (AISI 316)
- Sızdırmazlık: Mekanik salmastra (Karbon/Seramik/Viton) (CMF4): Ø16 (CMF8, CMF12, CMF16): Ø19
- Sıvı sıcaklığı: +5°C ~ +90°C
- Devir Hızı: 2900d/dak.
- Koruma sınıfı: IP 55
- İzolasyon sınıfı: F
- Emme derinliği: 6.5mt.

TECHNICAL DATA

- Impeller: S/S (AISI 316)
- Diffuser: S/S (AISI 316)
- Pump Body: S/S (AISI 316)
- Shaft: S/S (AISI 316)
- Non-Leakage: Mechanical seal (Carbon/Ceramic/Viton) (CMF4): Ø16 (CMF8, CMF12, CMF16): Ø19
- Liquid Temp.: +5°C ~ +90°C
- Speed: 2900 rpm.
- Protection Class: IP55
- Insulation Class: F
- Suction lift: Max 6.5 m.



KULLANIM ALANLARI

- İçme suyu, maden suyu, saf su Yanıcı ve Patlayıcı içermeyen temiz ve lifsiz sular
- Endüstriyel ve kimyasal prosesler
- Deniz suyu
- Arıtma tesisleri
- Gıda sanayi (Süt, Meyve ve Salamura Suyu vs.)
- Hafif yağlar
- Hidrofor sistemleri
- Soğutma sistemleri

APPLICATIONS

- Drinking water, mineral and pure water, Non-flammable, non-explosive liquids containing no granules and fibre
- Industrial and chemical processes
- Sea water
- Water treatment
- Food industry (milk, fruit juices, saltwater)
- Light oil
- Booster systems
- Chiller systems

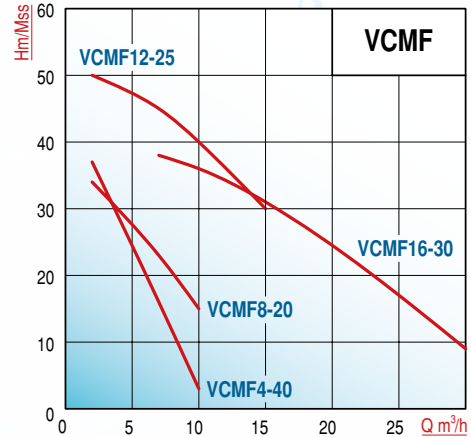
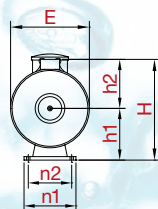
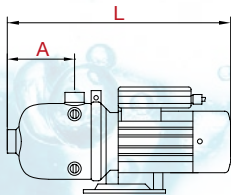

TİP TYPE	Boyutlar - Dimensions (mm)								Ağırlık - Weight
	A	L	h1	h2	H	E	n1	n2	Kg
VCMF4-40	130	400	110	98	230	165	130	108	12
VCMF8-20	138	420	120	122	250	204	130	108	14
VCMF12-25	138	510	120	122	261	204	130	108	18
VCMF16-30	162	520	120	122	261	205	130	108	23

VCM

KOMPLE PASLANMAZ ÇELİK (AISI 316) KADEMELİ POMPALAR

STAINLESS STEEL(AISI 316) MULTI-STAGE PUMPS

TİP TYPE	Bağlantı Giriş x Çıkış Inlet x Outlet	MOTOR						Kademe Stage	m ³ /h Hm (mss)	Debi (Q) - Capacity					
		HP	kW	V		A				1	3	4	5	7	10
				Mono	Tri	Mono	Tri								
VCM4-60T	1 ¼" x 1"	1,5	1,1	-	380	-	2,4	6	56	51	46	41	26		
VCM8-40T	1.5" x 1.5"	3	2,2	-	380	-	5,2	4	73	67	64	60	52	36	

TEKNİK ÖZELLİKLER

- Çark: Paslanmaz Çelik (AISI 316)
- Difüzör: Paslanmaz Çelik (AISI 316)
- Gövde: Paslanmaz Çelik (AISI 316)
- Mil: Paslanmaz Çelik (AISI 316)
- Sızdırmazlık: Mekanik salmastra (Karbon/Seramik/Viton) (CM4): Ø16, (CM8): Ø19
- Sıvı sıcaklığı: +5°C ~ +90°C
- Devir Hızı: 2900d/dak.
- Koruma sınıfı: IP 55
- İzolasyon sınıfı: F
- Emme derinliği: 6.5mt.

TECHNICAL DATA

- Impeller: S/S (AISI 316)
- Diffuser: S/S (AISI 316)
- Pump Body: S/S (AISI 316)
- Shaft: S/S (AISI 316)
- Non-Leakage: Mechanical seal (Carbon/Ceramic/Viton) (CM4): Ø16, (CM8): Ø19
- Liquid Temp.: +5°C ~ +90°C
- Speed: 2900 rpm.
- Protection Class: IP55
- Insulation Class: F
- Suction lift: Max 6.5 m.

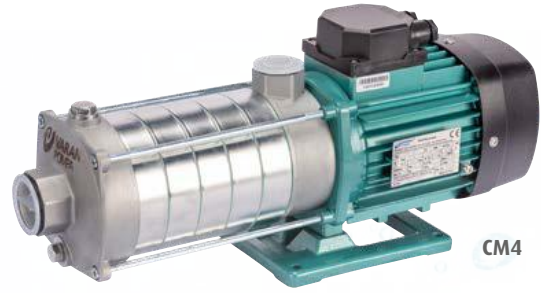

CM4

**AISI
316**



CM8

KULLANIM ALANLARI

- İçme suyu, maden suyu, saf su
- Yanıcı ve Patlayıcı içermeyen temiz ve lifsiz sular
- Endüstriyel ve kimyasal prosesler
- Deniz suyu
- Arıtma tesisleri
- Gıda sanayi (Süt, Meyve ve Salmura Suyu vs.)
- Hafif yağlar
- Hidrofor sistemleri
- Soğutma sistemleri

APPLICATIONS

- Drinking water, mineral and pure water, Non-flammable, non-explosive liquids containing no granules and fibre
- Industrial and chemical processes
- Sea water
- Water treatment
- Food industry (milk, fruit juices, saltwater)
- Light oil
- Booster systems
- Chiller systems

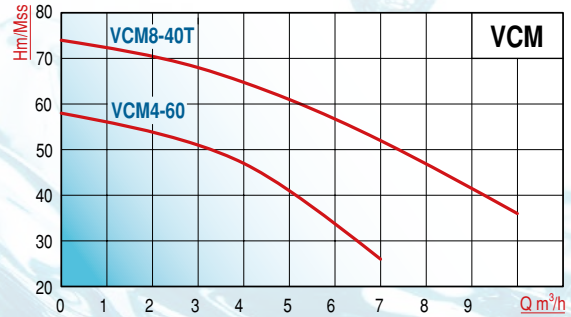
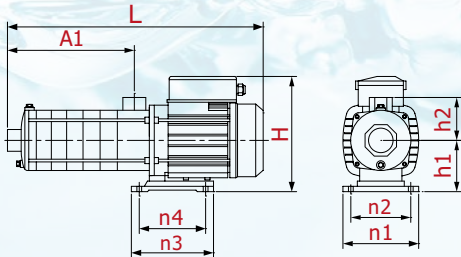

TİP TYPE	Boyutlar - Dimensions (mm)										Ağırlık - Weight Kg
	A	L	h1	h2	H	n1	n2	n3	n4		
VCM4-60	217	443	90	72	162	133	108	180	138	11	
VCM4-60T	217	443	90	72	162	133	108	180	138	11	
VCM8-40T	168	480	118	110	228	130	108	180	138	26	

VCMİ

KOMPLE PASLANMAZ ÇELİK (AISI 304) KADEMELİ POMPALAR

STAINLESS STEEL(AISI 304) MULTI-STAGE PUMPS

TİP TYPE	Bağlantı		MOTOR				Kademe Stage	m ³ /h	Debi (Q) - Capacity								
	Giriş x Çıkış Inlet x Outlet		HP	kW	V				A		1	2	4	6	8	10	14
					Mono	Tri			Mono	Tri							
VCMİ4-5	1¼" x 1"		1	0,75	220	380	5,2	1,9	5	Hm (mSS)	48	46	38	23			
VCMİ4-7	1¼" x 1"		1,5	1,1	220	380	7	3,5	7		67	64	55	38			
VCMİ8-30	1½" x 1½"		2,5	1,85	220	380	13	4,1	3		55	54	50	44	32	26	
VCMİ8-40T	1½" x 1½"		3	2,2	-	380	-	5,2	4		68	67	65	57	43	34	
VCMİ10-5T	1½" x 1½"		4	3	-	380	-	6,5	5		77,5	77	76,5	75	71	63	46

TEKNİK ÖZELLİKLER

- Çark: Paslanmaz Çelik (AISI 304)
- Difüzör: Paslanmaz Çelik (AISI 304)
- Gömlek: Paslanmaz Çelik (AISI 304)
- Mil: Paslanmaz Çelik (AISI 304)
- Sızdırmazlık: Mekanik salmastra (Karbon/Sic/Viton)
- Sıvı sıcaklığı: +5°C ~ +90°C
- Devir Hızı: 2900d/dak.
- Koruma sınıfı: IP 55
- İzolasyon sınıfı: F
- Emme derinliği: 6.5mt.

TECHNICAL DATA

- Impeller: S/S (AISI 304)
- Diffuser: S/S (AISI 304)
- Pump Body: Cast iron GG-25
- Shaft: S/S (AISI 304)
- Non-Leakage: Mechanical seal (Carbon/Sic/Viton)
- Liquid Temp.: +5°C ~ +90°C
- Speed: 2900 rpm.
- Protection Class: IP55
- Insulation Class: F
- Suction lift: Max 6.5 m.



KULLANIM ALANLARI

- İçme suyu, maden suyu, saf su
- Yanıcı ve Patlayıcı içermeyen temiz ve lifsiz sular
- Endüstriyel ve kimyasal prosesler
- Arıtma tesisleri
- Gıda sanayi
- Hafif yağlar
- Hidrofor sistemleri
- Soğutma sistemleri

APPLICATIONS

- Drinking water, mineral and pure water, Non-flammable, non-explosive liquids containing no granules and fibre
- Industrial and chemical processes
- Water treatment
- Food industry
- Light oil
- Booster systems
- Chiller systems

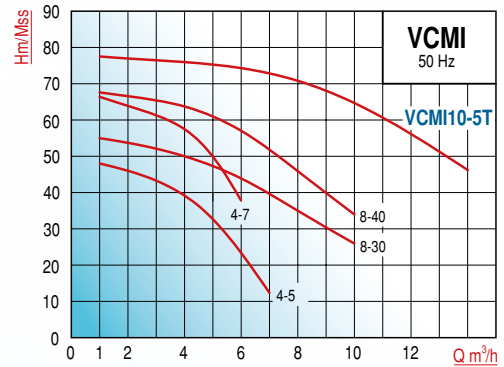
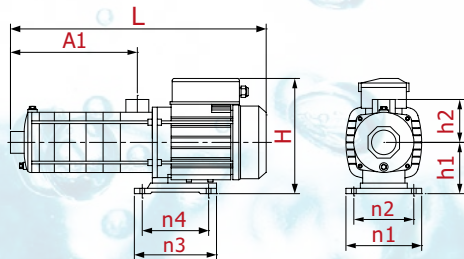

TİP TYPE	Boyutlar - Dimensions (mm)									Ağırlık - Weight
	A	L	h1	h2	H	n1	n2	n3	n4	Kg
VCMİ4-5	104	378	75	86	188	158	125	155	96	12,5
VCMİ4-7	140	414	75	86	188	158	125	155	96	15
VCMİ8-30T	100	408	100	108	217	158	125	136	96	21
VCMİ8-40T	130	438	100	108	217	158	125	138	96	23
VCMİ10-5T	190	558	100	108	212	199	160	172	140	26

VCVL

KOMPLE PASLANMAZ ÇELİK (AISI 304) KADEMELİ POMPALAR

STAINLESS STEEL(AISI 304) MULTI-STAGE PUMPS

TİP TYPE	Bağlantı Giriş x Çıkış Inlet x Outlet	MOTOR				KADEME STAGE	m ³ /h	Debi (Q) - Capacity					
		HP	kW	V	A			1	2	2,5	3	3,5	4
VCVL3-12	1 ¼" x 1 ¼"	1,5	1,1	380	2,5	12	72	66	59	52	44	34	
VCVL3-15	1 ¼" x 1 ¼"	1,5	1,1	380	2,5	15	90	82	77	69	60	44	
VCVL3-19	1 ¼" x 1 ¼"	2	1,5	380	3	19	113	104	98	88	77	58	
VCVL3-29	1 ¼" x 1 ¼"	3	2,2	380	4,5	29	170	156	147	132	118	93	

Flanşlar hariçtir. Takım fiyatı: 80 USD

TİP TYPE	Bağlantı Giriş x Çıkış Inlet x Outlet	MOTOR				KADEME STAGE	m ³ /h	Debi (Q) - Capacity					
		HP	kW	V	A			2	3	4	5	6,5	8
VCVL5-12	1 ¼" x 1 ¼"	3	2,2	380	4,5	12	75	73	68	62	49	36	
VCVL5-16	1 ¼" x 1 ¼"	3	2,2	380	4,5	16	103	100	94	85	69	48	
VCVL5-20	1 ¼" x 1 ¼"	4	3	380	6	20	129	122	115	105	86	60	
VCVL5-29	1 ¼" x 1 ¼"	5,5	4	380	7,8	29	185	177	168	157	132	87	

Flanşlar hariçtir. Takım fiyatı: 80 USD

TİP TYPE	Bağlantı Giriş x Çıkış Inlet x Outlet	MOTOR				KADEME STAGE	m ³ /h	Debi (Q) - Capacity					
		HP	kW	V	A			2	6	8	10	12	14
VCVL10-7	1½" x 1½"	4	3	380	6	7	73	67	61	54	43	32	
VCVL10-9	1½" x 1½"	4	3	380	6	9	93	87	81	71	59	42	
VCVL10-12	1½" x 1½"	5,5	4	380	7,8	12	123	117	108	95	78	55	
VCVL10-16	1½" x 1½"	7,5	5,5	380	10,3	16	163	154	143	125	102	71	

Flanşlar hariçtir. Takım fiyatı: 105 USD

TİP TYPE	Bağlantı Giriş x Çıkış Inlet x Outlet	MOTOR				KADEME STAGE	m ³ /h	Debi (Q) - Capacity					
		HP	kW	V	A			8	12	15	18	20	24
VCVL15-7	2" x 2"	7,5	5,5	380	10,3	7	94	88	80	71	64	50	
VCVL15-9	2" x 2"	10	7,5	380	14,1	9	122	115	106	95	87	66	
VCVL15-12	2" x 2"	15	11	380	20,5	12	158	150	140	126	116	89	
VCVL15-14	2" x 2"	15	11	380	20,5	14	183	172	162	145	133	103	

Flanşlar hariçtir. Takım fiyatı: 105 USD

TİP TYPE	Bağlantı Giriş x Çıkış Inlet x Outlet	MOTOR				KADEME STAGE	m ³ /h	Debi (Q) - Capacity					
		HP	kW	V	A			8	12	16	20	24	28
VCVL20-7	2" x 2"	10	7,5	380	14,1	7	96	92	86	77	65	47	
VCVL20-10	2" x 2"	15	11	380	20,5	10	137	132	124	112	98	73	
VCVL20-14	2" x 2"	20	15	380	28	14	191	186	176	161	140	110	

Flanşlar hariçtir. Takım fiyatı: 105 USD

TEKNİK ÖZELLİKLER

- Çark: Paslanmaz Çelik (AISI 304)
- Difüzör: Paslanmaz Çelik (AISI 304)
- Gövde: Paslanmaz Çelik (AISI 304)
- Mil: Paslanmaz Çelik (AISI 304)
- Sızdırmazlık: Mekanik salmastra (Karbon/Silisyum/Viton)
- Sıvı sıcaklığı: +5°C ~ +90°C
- Devir Hızı: 2900d/dak.
- Koruma sınıfı: IP 55
- İzolasyon sınıfı: F
- Emme derinliği: 6.5mt.

TECHNICAL DATA

- Impeller: S/S (AISI 304)
- Diffuser: S/S (AISI 304)
- Pump Body: S/S (AISI 304)
- Shaft: S/S (AISI 304)
- Non-Leakage: Mechanical seal (Carbon/Silicon/Viton)
- Liquid Temp.: +5°C ~ +90°C
- Speed: 2900 rpm.
- Protection Class: IP55
- Insulation Class: F
- Suction lift: Max 6.5 m.

KULLANIM ALANLARI

- İçme suyu, maden suyu, saf su, yanıcı ve patlayıcı içermeyen temiz ve lifsiz sular
- Endüstriyel ve kimyasal prosesler
- Arıtma tesisleri
- Gıda sanayi (Süt, Meyve ve Salamura Suyu vs.)
- Hafif yağlar
- Hidrofor sistemleri
- Soğutma sistemleri

APPLICATIONS

- Drinking water, mineral and pure water, Non-flammable, non-explosive liquids containing no granules and fibre
- Industrial and chemical processes
- Water treatment
- Food industry (milk, fruit juices, salt-water)
- Light oil
- Booster systems
- Chiller systems

VCVL
KOMPLE PASLANMAZ ÇELİK (AISI 304) KADEMELİ POMPALAR

STAINLESS STEEL(AISI 304) MULTI-STAGE PUMPS

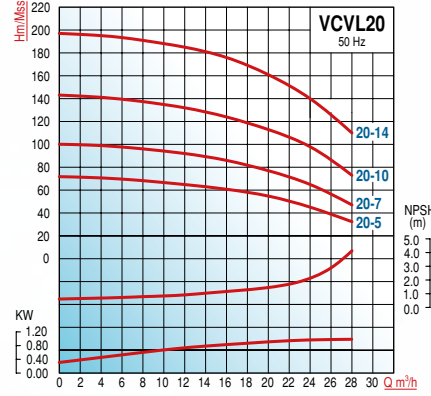
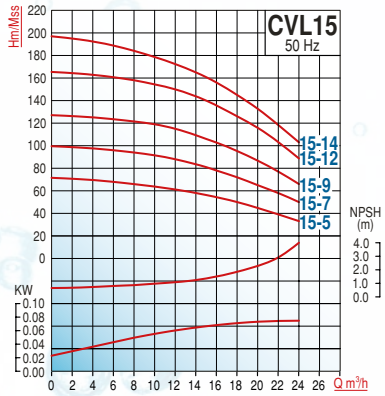
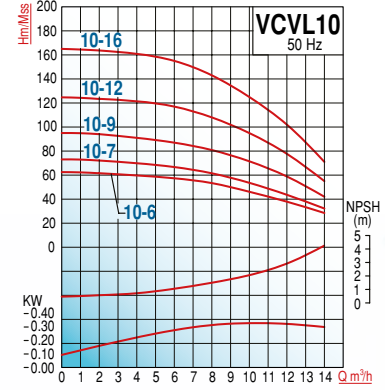
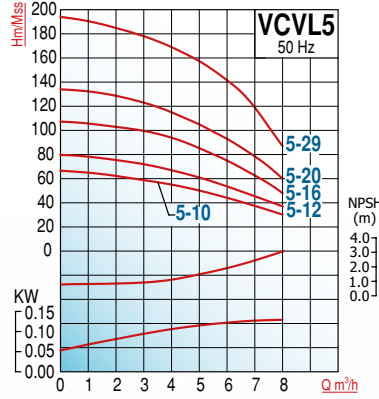
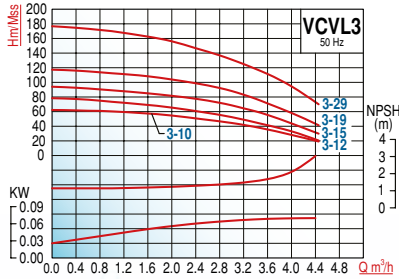

TİP TYPE	Boyutlar - Dimensions (mm)										
	h	H	DN	k1	k2	L	n1	n2	n3	n4	Ød
VCVL3-10	75	416	32	125	125	250	150	100	213	180	13
VCVL3-12	75	445	32	125	125	250	150	100	213	180	13
VCVL3-15	75	514	32	125	125	250	150	100	213	180	13
VCVL3-19	75	596	32	125	125	250	150	100	213	180	13
VCVL3-29	75	776	32	125	125	250	150	100	213	180	13
VCVL5-10	75	524	32	125	125	250	150	100	213	180	13
VCVL5-12	75	561	32	125	125	250	150	100	213	180	13
VCVL5-16	75	686	32	125	125	250	150	100	213	180	13
VCVL5-20	75	794	32	125	125	250	150	100	213	180	13
VCVL5-29	75	1052	32	125	125	250	150	100	213	180	13
VCVL10-6	90	496	40	140	140	280	200	130	248	215	13,5
VCVL10-7	90	513	40	140	140	280	200	130	248	215	13,5
VCVL10-9	90	586	40	140	140	280	200	130	248	215	13,5
VCVL10-12	90	691	40	140	140	280	200	130	248	215	13,5
VCVL10-16	90	833	40	140	140	280	200	130	248	215	13,5
VCVL15-5	90	558	50	150	150	300	200	130	248	215	13,5
VCVL15-7	90	668	50	150	150	300	200	130	248	215	13,5
VCVL15-9	90	758	50	150	150	300	200	130	248	215	13,5
VCVL15-12	90	921	50	150	150	300	200	130	248	215	13,5
VCVL15-14	90	1011	50	150	150	300	200	130	248	215	13,5
VCVL20-5	90	582	50	150	150	300	200	130	248	215	13,5
VCVL20-7	90	668	50	150	150	300	200	130	248	215	13,5
VCVL20-10	90	830	50	150	150	300	200	130	248	215	13,5
VCVL20-14	90	1011	50	150	150	300	200	130	248	215	13,5

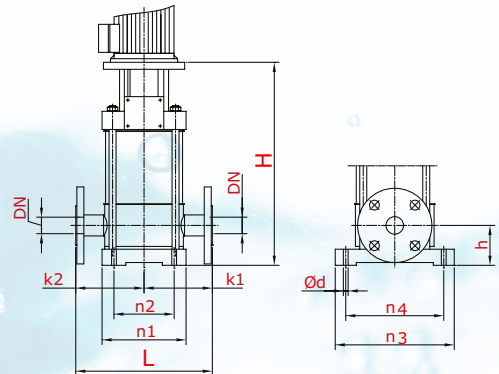

VCVF

KOMPLE PASLANMAZ ÇELİK (AISI 304) KADEMELİ POMPALAR

STAINLESS STEEL(AISI 304) MULTI-STAGE PUMPS

TİP TYPE	Bağlantı Giriş x Çıkış Inlet x Outlet	MOTOR				KADEME STAGE	m ³ /h	Debi (Q) - Capacity						
		HP	kW	V	A			Hm (mss)	12	20	24	30	36	40
VCVF32-5	2½" x 2½"	15	11	19,6	5	91	83	78	66	53	42			
VCVF32-6	2½" x 2½"	15	11	20,5	6	109	101	95	83	65	52			
VCVF32-8	2½" x 2½"	20	15	26,7	8	143	134	126	111	88	70			
VCVF32-10	2½" x 2½"	25	18,5	32,6	10	179	169	162	142	114	88			
VCVF32-12	2½" x 2½"	30	22	39,2	12	214	203	194	171	137	107			

*Alıcı - Verici Göve Pik Dökümdür.

TİP TYPE	Bağlantı Giriş x Çıkış Inlet x Outlet	MOTOR				KADEME STAGE	m ³ /h	Debi (Q) - Capacity						
		HP	kW	V	A			Hm (mSS)	25	30	35	45	50	55
*VCV45-4	3" x 3"	20	15	26,9	4	98	94	87	77	70	61			
VCVF45-5	3" x 3"	25	18,5	32,6	5	123	118	112	97	88	77			
VCVF45-6	3" x 3"	30	22	39,2	6	147	141	135	118	107	94			
VCVF45-9-2	3" x 3"	40	30	54,6	9	209	202	193	169	152	133			

*Alıcı - Verici Göve Pik Dökümdür.

TİP TYPE	Bağlantı Giriş x Çıkış Inlet x Outlet	MOTOR				KADEME STAGE	m ³ /h	Debi (Q) - Capacity						
		HP	kW	V	A			Hm (mSS)	30	40	50	64	70	80
VCVF64-4-2	4" x 4"	25	18,5	32,6	4	92	87	80	66	60	49			
VCVF64-4	4" x 4"	30	22	39,2	4	107	101	94	80	74	61			
VCVF64-6-2	4" x 4"	40	30	54,6	6	147	140	130	112	101	81			

*Alıcı - Verici Göve Pik Dökümdür.

TİP TYPE	Bağlantı Giriş x Çıkış Inlet x Outlet	MOTOR				KADEME STAGE	m ³ /h	Debi (Q) - Capacity						
		HP	kW	V	A			Hm (mss)	50	70	80	90	100	110
VCVF90-3-2	4" x 4"	25	18,5	32,6	3	68	60	55	49	41	33			
VCVF90-3	4" x 4"	30	22	39,2	3	83	73	67	61	54	47			
VCVF90-4-2	4" x 4"	40	30	54,6	4	98	87	80	72	62	50			

TEKNİK ÖZELLİKLER

- Çark: Paslanmaz Çelik (AISI 304)
- Difüzör: Paslanmaz Çelik (AISI 304)
- Gövde :GG-25 Pik Döküm / Döküm Paslanmaz Çelik (AISI 304)
- Mil: Paslanmaz Çelik (AISI 304)
- Sızdırmazlık: Mekanik salmastra (Karbon/Silisyum/Viton)
- Sıvı sıcaklığı: +5°C ~ +90°C
- Devir Hızı: 2900d/dak.
- Koruma sınıfı: IP 55
- İzolasyon sınıfı: F
- Emme derinliği: 6.5mt.

KULLANIM ALANLARI

- İçme suyu, maden suyu, saf su, yanıcı ve patlayıcı içermeyen temiz ve lıfızlı sular
- Endüstriyel ve kimyasal prosesler
- Arıtma tesisleri
- Gıda sanayi (Süt, Meyve ve Salamura Suyu vs.)
- Hafif yağlar
- Hidrofor sistemleri
- Soğutma sistemleri

TECHNICAL DATA

- Impeller: S/S (AISI 304)
- Diffuser: S/S (AISI 304)
- P-Pump Body: GG-25 Cast iron / S/S (AISI 304)
- Shaft: S/S (AISI 304)
- Non-Leakage: Mechanical seal (Carbon/Silicon/Viton)
- Liquid Temp.: +5°C ~ +90°C
- Speed: 2900 rpm.
- Protection Class: IP55
- Insulation Class: F
- Suction lift: Max 6.5 m.

APPLICATIONS

- Drinking water, mineral and pure water, Non-flammable, non-explosive liquids containing no granules and fibre
- Industrial and chemical processes
- Water treatment
- Food industry (milk, fruit juices, saltwater)
- Light oil
- Booster systems
- Chiller systems



VCFV
KOMPLE PASLANMAZ ÇELİK (AISI 304) KADEMELİ POMPALAR

STAINLESS STEEL(AISI 304) MULTI-STAGE PUMPS

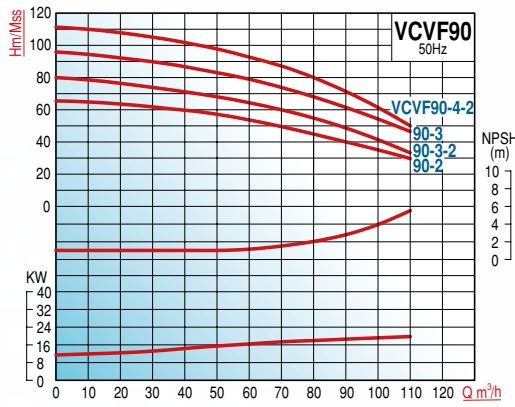
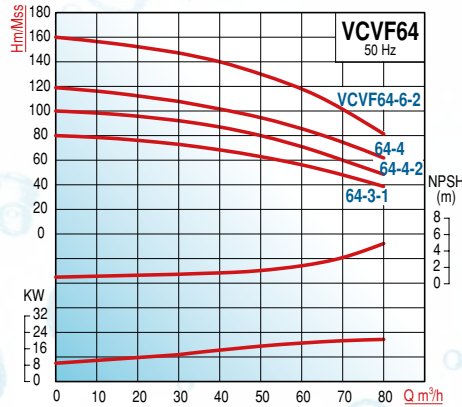
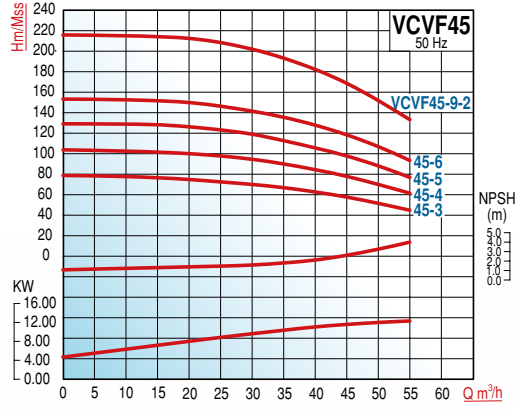
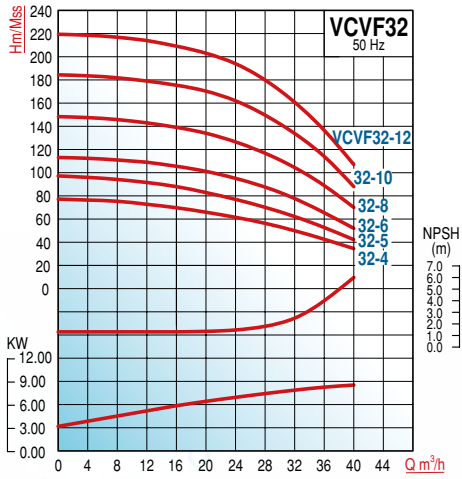

TİP TYPE	Boyutlar - Dimensions (mm)										
	h	H	DN	k1	k2	L	n1	n2	n3	n4	Ød
VCFV32-4	105	690	65	160	160	320	226	170	298	240	14
VCFV32-5	105	915	65	160	160	320	226	170	298	240	14
VCFV32-6	105	985	65	160	160	320	226	170	298	240	14
VCFV32-8	105	1125	65	160	160	320	226	170	298	240	14
VCFV32-10	105	1265	65	160	160	320	226	170	298	240	14
VCFV32-12	105	1405	65	160	160	320	226	170	298	240	14
VCFV45-3	140	826	80	182,5	182,5	365	251	190	331	266	14
VCFV45-4	140	906	80	182,5	182,5	365	251	190	331	266	14
VCFV45-5	140	986	80	182,5	182,5	365	251	190	331	266	14
VCFV45-6	140	1066	80	182,5	182,5	365	251	190	331	266	14
VCFV45-9-2	140	1306	80	182,5	182,5	365	251	190	331	266	14
VCFV64-3-1	140	836	100	182,5	182,5	365	251	190	331	266	14
VCFV64-4-2	140	919	100	182,5	182,5	365	251	190	331	266	14
VCFV64-4	140	919	100	182,5	182,5	365	251	190	331	266	14
VCFV64-6-2	140	1084	100	182,5	182,5	365	251	190	331	266	14
VCFV90-2	140	773	100	190	190	380	261	199	348	280	14
VCFV90-3-2	140	865	100	190	190	380	261	199	348	280	14
VCFV90-3	140	865	100	190	190	380	261	199	348	280	14
VCFV90-4-2	140	957	100	190	190	380	261	199	348	280	14

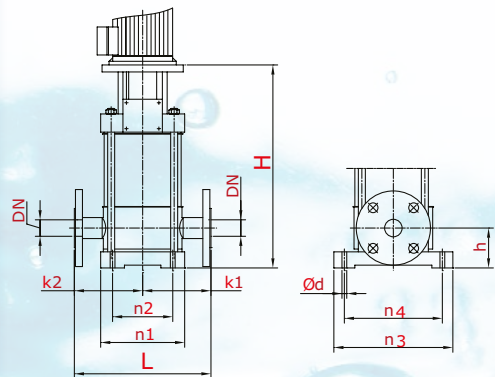

SÜRTME ÇARKLI (PREFERİKAL) POMPALAR

PERIPHERAL PUMPS

TİP TYPE	Bağlantı Giriş x Çıkış Inlet x Outlet	HP	kW	MOTOR				m ³ /h	Debi (Q) - Capacity				
				V		A			0.6	1	1.5	2	3
				Mono	Tri	Mono	Tri						
QB60	1"x1"	0,5	0,37	220		2,5		Hm (mSS)	35	29	20	10	
QB60	1"x1"	0,5	0,37		380		1		35	29	20	10	
QB80	1"x1"	1	0,75	220		5,5			60	56	50	40	22
QB80	1"x1"	1	0,75		380		1,8		60	56	50	40	22

TEKNİK ÖZELLİKLER

- Çark: Bronz
- Gövde: Pik döküm GG-25 (Gövde iç kısım prinç kaplı)
- Mil: Çelik (C1050 Krom kaplı)
- Sızdırmazlık: Mekanik salmastra (Karbon/Seramik/NBR) Ø12
- Sıvı sıcaklığı: +5°C ~ +60°C
- Devir Hızı: 2900d/dak.
- Koruma sınıfı: IP 44
- İzolasyon sınıfı: F
- Emme derinliği: 6.5mt.

TECHNICAL DATA

- Impeller: Bronze
- Pump Body: GG-25 Cast iron (Brass plated body)
- Shaft: Steel (C1050 Chrome plated)
- Non-Leakage: Mechanical seal (Carbon/Ceramic/NBR) Ø12
- Liquid Temp.: +5°C ~ +60°C
- Speed: 2900 rpm.
- Protection Class: IP44
- Insulation Class: F
- Suction lift: Max 6.5 m.



KULLANIM ALANLARI

- Yüksek basınç
- Hidrofor sistemleri
- Konutlar
- Bahçe sulama
- Endüstri ve inşaatlar
- Besi kazanları

APPLICATIONS

- High pressure
- Booster systems
- Residences
- Irrigation
- Industrial plants, Constructions
- Boilers

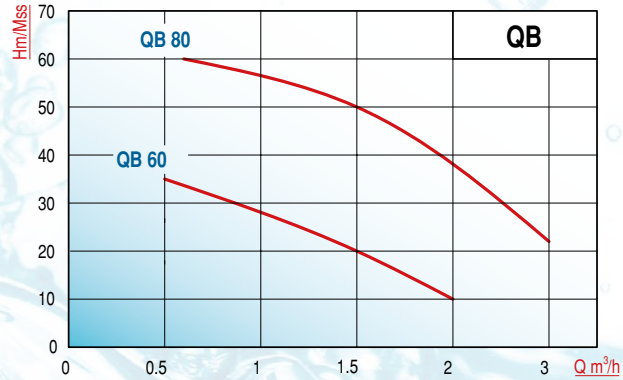
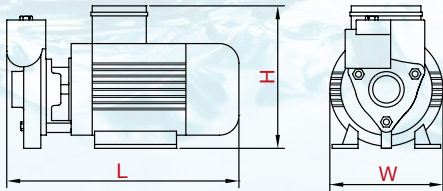

TİP TYPE	Boyutlar - Dimensions (mm)			Ağırlık Weight Kg.
	Boy-L	Yük-H	En-W	
	Length	Height	Width	
QB 60	250	160	125	5.4
QB 80	310	180	130	10

KS

ÇİFT KADEMELİ MONOBLOK POMPALAR

DOUBLE STAGE CLOSE COUPLED PUMPS

TİP TYPE	Bağlantı Giriş x Çıkış Inlet x Outlet	MOTOR						m ³ /h	Debi (Q) - Capacity					
		HP	kW	V		A			1.5	3	5	7	10	15
	Mono			Tri	Mono	Tri								
KS-115	1"x1"	1.5	1.1	220	380	7.3	2.5	41	38	31	20			
KS-12	1"x1"	2	1.5	220	380	11.2	3.18	46	43	37	30			
KS-142	1 1/4" x 1 1/4"	2	1.5	220	380	11.2	3.18	50	47	43	37	28		
KS-143	1 1/4" x 1 1/4"	3	2.2	220	380	14.9	4.8	55	53	49	45	38		
KS-155	1.5" x 1 1/4"	5.5	4.0	-	380	-	8.8	67	64	61	58	52	40	
KS-157	1.5" x 1.5"	7.5	5.5	-	380/660	-	10.5	70	68	66	62	56	47	
KS-255	2" x 2"	5.5	4.0	-	380	-	8.8	67	64	61	58	52	40	
KS-27	2" x 2"	7.5	5.5	-	380/660	-	10.5	70	68	66	62	56	47	

TEKNİK ÖZELLİKLER

- MOTOR: Yüksek verimli sınıf
- Çark: Alüminyum/PC
- Gövde: Pük döküm GG-25
- Mil: AISI420 Paslanmaz Çelik
- Sızdırmazlık: Mekanik salmastra (Karbon/Seramik/NBR) (KS-1, KS-14): Ø19, (KS-15, KS-2): Ø25
- Sıvı sıcaklığı: +5°C ~ +60°C
- Devir Hızı: 2900d/dak.
- Koruma sınıfı: IP 54
- İzolasyon sınıfı: F
- Emme derinliği: 6.5mt.

TECHNICAL DATA

- MOTOR: High efficiency class
- Impeller: Aluminium/PC
- Pump Body: GG-25 Cast iron
- Shaft: Stainless Steel (AISI420)
- Non-Leakage: Mechanical seal (Carbon/Ceramic/NBR) (KS-1, KS-14): Ø19, (KS-15, KS-2): Ø25
- Liquid Temp.: +5°C ~ +60°C
- Speed: 2900 rpm.
- Protection Class: IP54
- Insulation Class: F
- Suction lift: Max 6.5 m.



KS-115, KS-12



KS-155, KS-157
KS-255, KS-27



KS-142, KS-143
KS-255

KULLANIM ALANLARI

- Temiz su
- Basıncılı su
- Hidrofor sistemleri
- Konutlar, İş Merkezleri
- Bahçe sulama (Damlatma ve Sprink sistemleri)
- Endüstri ve İnşaatlar
- Soğutma sistemleri

APPLICATIONS

- Clean water
- Pressurized water
- Booster systems
- Residences, Business centers
- Irrigation (Drip and Sprinkler systems)
- Industrial plants, Constructions
- Chiller systems

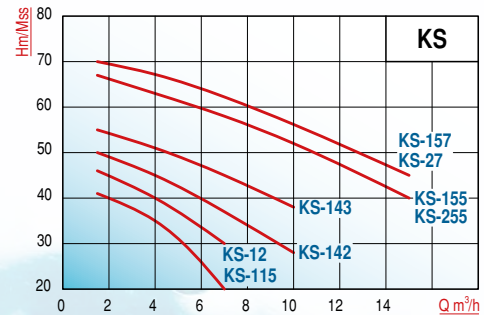

TİP TYPE	Boyutlar - Dimensions (mm)						Ağırlık - Weight	
	A	L	h1	h2	H	E	Kg	
KS-115	104	460	96	144	240	195	27	
KS-12	104	460	96	144	240	195	29	
KS-142	112	470	110	130	240	225	33	
KS-143	112	470	110	130	240	225	33	
KS-155	90	470	132	168	300	280	40	
KS-157	90	515	132	173	305	280	49	
KS-255	90	470	132	168	300	280	40	
KS-27	90	515	136	169	305	280	49	

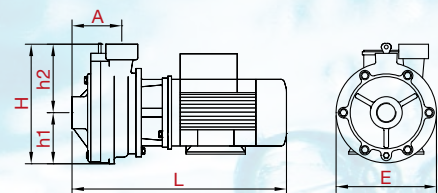

ÇİFT KADEMELİ MONOBLOK POMPALAR

DOUBLE STAGE CLOSE COUPLED PUMPS

TİP TYPE	Bağlantı Giriş x Çıkış Inlet x Outlet	MOTOR						m ³ /h	Debi (Q) - Capacity					
		HP	kW	V		A			1,5	4	6	9	11	15
				Mono	Tri	Mono	Tri							
2HCP25/140H	1¼"x1"	1,5	1,1	220	-	6,8	-	Hm (mSS)	46	40	33			
2HCP-160B	1¼"x1"	2	1,5	220	380	10,5	3,8		50	43	34	8		
2HCP-180	1.5"x1¼"	3	2,2	220	380	11,5	4,5		57	50	41	22	10	
2HCP-200	1.5"x1¼"	4	3,0	-	380	-	7,5		62	57	52	42	36	10

TEKNİK ÖZELLİKLER

- Çark: Bronz
- Gövde: Pik döküm GG-25
- Mil: Çelik
- Sızdırmazlık: Mekanik salmastra (Karbon/Seramik/NBR) Ø17
- Sıvı sıcaklığı: +5°C ~ +60°C
- Devir Hızı: 2900d/dak.
- Koruma sınıfı: IP 54
- İzolasyon sınıfı: F
- Emme derinliği: 6.5mt.

TECHNICAL DATA

- Impeller: Bronze
- Pump Body: GG-25 Cast iron
- Shaft: Steel
- Non-Leakage: Mechanical seal (Carbon/Ceramic/NBR) Ø17
- Liquid Temp.: +5°C ~ +60°C
- Speed: 2900 rpm.
- Protection Class: IP54
- Insulation Class: F
- Suction lift: Max 6.5 m.

KULLANIM ALANLARI

- Temiz su
- Basıncı su
- Hidrofor sistemleri
- Konutlar, İş Merkezleri
- Bahçe sulama (Damlama ve Sprink sistemleri)
- Endüstri ve İnşaatlar
- Soğutma sistemleri

APPLICATIONS

- Clean water
- Pressurized water
- Booster systems
- Residences, Business centers
- Irrigation (Drip and Sprinkler systems)
- Industrial plants, Constructions
- Chiller systems



2TCP

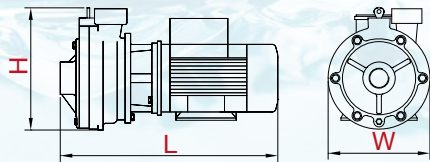

TİP TYPE	Boyutlar - Dimensions (mm)			Ağırlık Weight Kg.
	Boy-L	Yük-H	En-W	
	Length	Height	Width	
2HCP25/140H	445	270	230	22
2HCP-160B	405	270	225	27
2HCP-180	450	290	240	32
2HCP-200	480	320	260	42

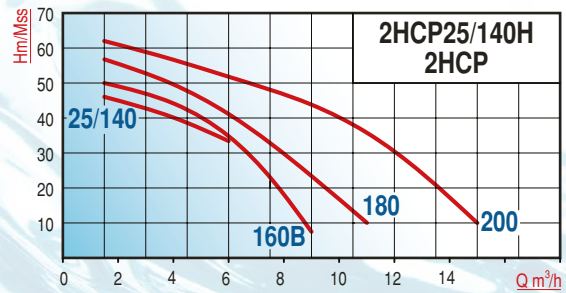

CS-1 & CS-15

KOMPAKT MONOBLOK SANTRİFÜJ POMPALAR (KAPALI VE AÇIK ÇARKLI)

COMPACT CLOSE-COUPLED CENTRIFUGAL PUMPS (OPEN AND CLOSED IMPELLER)

TİP TYPE	Bağlantı Giriş x Çıkış Inlet x Outlet	MOTOR						m ³ /h Hm (mSS)	Debi (Q) - Capacity				
		HP	kW	V		A			1.5	3	5	6	8
				Mono	Tri	Mono	Tri						
CS-11	1"x1"	1	0.75	220	380	4.95	1.8	29	26	21	18	10	
CS-115		1.5	1.1	220	380	7.8	2.49	31	29	26	24	20	
CS-12		2	1.5	220	380	11.2	3.4	32	31	28	26	23	

TİP TYPE	Bağlantı Giriş x Çıkış Inlet x Outlet	MOTOR						m ³ /h Hm (mSS)	Debi (Q) - Capacity				
		HP	kW	V		A			1.5	5	8	12	16
				Mono	Tri	Mono	Tri						
CS-151	1.5"x1.5"	1	0.75	220	380	4.95	1.8	26	22	17	10	3	
CS-155		1.5	1.1	220	380	7.8	2.49	29	25	20	13	6	
CS-152		2	1.5	220	380	11.2	3.4	31	28	24	17	9	
CS-153		3	2.2	220	380	14.8	4.9	32	30	27	20	12	

TEKNİK ÖZELLİKLER

- Çark: PC (CS-1 & CS15) / Alüminyum
- Gövde: Pik döküm GG-25
- Mil: Çelik (AISI 420)
- Sızdırmazlık: Mekanik salmastra (Karbon/Seramik/NBR) Ø19
- Sıvı sıcaklığı: +5°C ~ +60°C
- Devir Hızı: 2900d/dak.
- Frekans: 50Hz
- Koruma sınıfı: IP 54
- İzolasyon sınıfı: F
- Emme derinliği: 6.5mt.

TECHNICAL DATA

- Impeller: PC (CS-1&CS-15) / Aluminium
- Pump Body: GG-25 Cast iron
- Shaft: Steel (AISI 420)
- Non-Leakage: Mechanical seal (Carbon/Ceramic/NBR) Ø19
- Liquid Temp.: +5°C ~ +60°C
- Speed: 2900 rpm.
- Frequency: 50Hz
- Protection Class: IP54
- Insulation Class: F
- Suction lift: Max 6.5 m.

KULLANIM ALANLARI

- Temiz su temini
- Bahçe sulama (Damla ve Sprink sistemleri)
- Endüstri ve İnşaatlar
- Soğutma sistemleri

APPLICATIONS

- Clean water supply
- Irrigation (Drip and Sprinkler systems)
- Industrial plants, Constructions
- Chiller systems

OPSİYONEL

- Açık Çark
- Bronz Çark
- AISI 316 / AISI 304 Çelik Mil

OPTIONAL

- Open Impeller
- Bronze Impeller
- AISI 316 / AISI 304 S/S Shaft



CS-1
CS-15

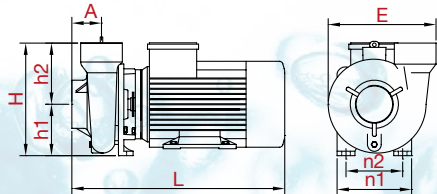

TİP TYPE	Boyutlar - Dimensions (mm)								Ağırlık - Weight Kg
	A	L	h1	h2	H	E	n1	n2	
CS-11	40	355	96	144	240	190	185	142	18
CS-115	40	355	96	144	240	190	185	142	19
CS-12	40	390	96	159	255	200	185	142	24
CS-151	60	365	95	140	235	190	185	142	19
CS-155	60	365	95	140	235	190	185	142	20
CS-152	60	390	95	160	255	200	185	142	24
CS-153	60	380	95	165	260	190	185	142	25

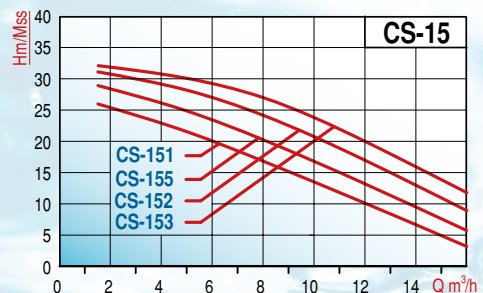
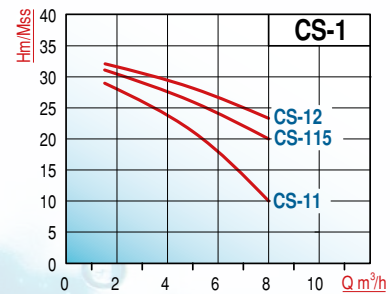

CS-2 & CS-3

KOMPAKT MONOBLOK SANTRİFÜJ POMPALAR (KAPALI VE AÇIK ÇARKLI)

COMPACT CLOSE-COUPLED CENTRIFUGAL PUMPS (OPEN AND CLOSED IMPELLER)

TİP TYPE	Bağlantı Giriş x Çıkış Inlet x Outlet	MOTOR						m ³ /h	Debi (Q) - Capacity				
		HP	kW	V		A			7	14	21	27	30
				Mono	Tri	Mono	Tri						
CS-21	2" x 2"	1	0.75	220	380	4.95	1.8	Hm (mSS)	15	11	5		
CS-215		1.5	1.1	220	380	7.8	2.5		20	16	10	3	
CS-22		2	1.5	220	380	11.2	3.4		24	20	14	8	4
CS-23		3	2.2	220	380	14.8	4.9		28	25	19	13	9

TİP TYPE	Bağlantı Giriş x Çıkış Inlet x Outlet	MOTOR						m ³ /h	Debi (Q) - Capacity				
		HP	kW	V		A			20	30	40	50	60
				Mono	Tri	Mono	Tri						
CS-315	3" x 3"	1.5	1.1	220	380	7.8	2.5	Hm (mSS)	11	9	6	2	
CS-32		2	1.5	220	380	11.2	3.4		14	12	9	5	1
CS-33		3	2.2	220	380	14.8	4.9		17	15	12	9	5

TEKNİK ÖZELLİKLER

- Çark: GG-25 PİK (CS-2 & CS-3)
- Gövde: PİK döküm GG-25
- Mil: Çelik (AISI 420)
- Sızdırmazlık: Mekanik salmastra (Karbon/Seramik/NBR) Ø19
- Sıvı sıcaklığı: +5°C ~ +60°C
- Devir Hızı: 2900d/dak.
- Frekans: 50Hz
- Koruma sınıfı: IP 54
- İzolasyon sınıfı: F
- Emme derinliği: 6.5mt.

TECHNICAL DATA

- Impeller: Cast iron GG-25 (CS-2 & CS-3)
- Pump Body: GG-25 Cast iron
- Shaft: Steel (AISI 420)
- Non-Leakage: Mechanical seal (Carbon/Ceramic/NBR) Ø19
- Liquid Temp.: +5°C ~ +60°C
- Speed: 2900 rpm.
- Frequency: 50Hz
- Protection Class: IP54
- Insulation Class: F
- Suction lift: Max 6.5 m.



CS-2



CS-3

KULLANIM ALANLARI

- Temiz su temini
- Bahçe sulama (Damlatma ve Sprink sistemleri)
- Endüstri ve inşaatlar
- Soğutma sistemleri

APPLICATIONS

- Clean water supply
- Irrigation (Drip and Sprinkler systems)
- Industrial plants, Constructions
- Chiller systems

OPSİYONEL

- Açık Çark
- Bronz Çark
- AISI 316 / AISI 304 Çelik Mil

OPTIONAL

- Open Impeller
- Bronze Impeller
- AISI 316 / AISI 304 S/S Shaft

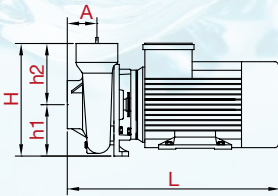

TİP TYPE	Boyutlar - Dimensions (mm)								Ağırlık - Weight
	A	L	h1	h2	H	E	n1	n2	Kg
CS-21	52	370	95	175	270	200	185	142	20
CS-215	52	370	95	175	270	200	185	142	22
CS-22	52	390	95	165	260	210	185	142	26
CS-23	52	395	95	170	265	200	185	142	27
CS-315	64	390	106	164	270	240	185	142	23
CS-32	64	430	106	164	270	240	185	142	28
CS-33	64	430	106	164	270	240	185	142	30

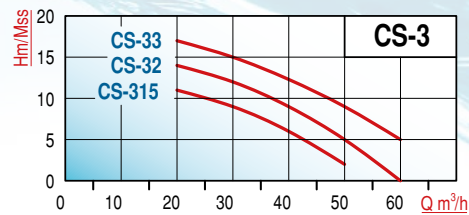
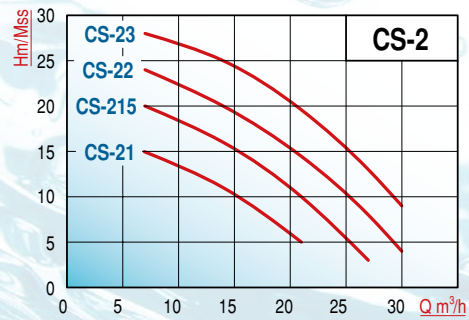

MONOBLOK SANTRİFÜJ POMPALAR

CENTRIFUGAL PUMPS

TİP TYPE	Bağlantı Giriş x Çıkış Inlet x Outlet	MOTOR						m ³ /h H _m (mSS)	Debi (Q) - Capacity					
		HP	kW	V		A			2	6	12	18	24	30
				Mono	Tri	Mono	Tri							
SP-1100T	1,5" x 1¼"	1,5	1,1	-	380	-	2,6	28	26	22	16			
SP-1500T	2" x 1,5"	2	1,5	-	380	-	3,5	31	30	28	22	11		
SP-2200T	2" x 1,5"	3	2,2	-	380	-	4,9	33	32	30	27	21	14	

TEKNİK ÖZELLİKLER

- Çark: AISI304 Paslanmaz Çelik
- Gövde: Pik döküm GG-25
- Mil: AISI304 Paslanmaz Çelik
- Sızdırmazlık: Mekanik salmastra (Karbon/Silisyum/Viton)
- Sıvı sıcaklığı: +5°C ~ +90°C
- Devir Hızı: 2900d/dak.
- Frekans: 50Hz
- Koruma sınıfı: IP 55
- İzolasyon sınıfı: B
- Emme derinliği: 6.5mt.

TECHNICAL DATA

- Impeller: AISI304 Stainless Steel
- Pump Body: GG-25 Cast iron
- Shaft: AISI304 Stainless Steel
- Non-Leakage: Mechanical seal (Carbon/Sic/Vit)
- Liquid Temp.: +5°C ~ +60°C
- Speed: 2900 rpm.
- Frequency: 50Hz
- Protection Class: IP55
- Insulation Class: B
- Suction lift: Max 6.5 m.



KULLANIM ALANLARI

- Temiz su temini
- Bahçe sulama (Damlama ve Sprink sistemleri)
- Endüstri ve İnşaatlar
- Soğutma sistemleri

APPLICATIONS

- Clean water supply
- Irrigation (Drip and Sprinkler systems)
- Industrial plants, Constructions
- Chiller systems

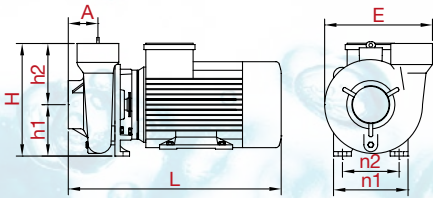

TİP TYPE	Boyutlar - Dimensions (mm)								Ağırlık - Weight	
	A	L	h1	h2	H	E	n1	n2	Kg	
SP-1100T	61	326	98	103	218	197	135	125	15	
SP-1500T	67	361	108	106	235	202	150	140	19	
SP-2200T	67	361	108	106	235	202	150	140	20	

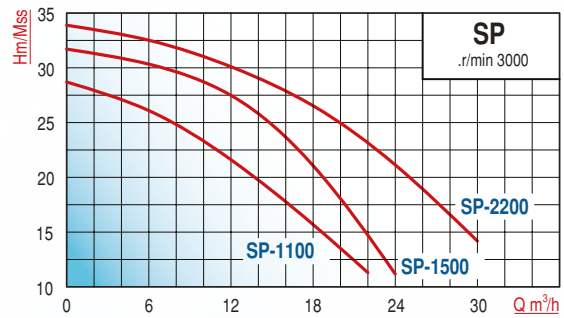

VS (3000 d/d)

MONOBLOK SALYANGOZ POMPALAR

VOLUTE CASING CLOSE-COUPLED PUMPS

TİP TYPE	Bağlantı Giriş x Çıkış Inlet x Outlet	MOTOR					m ³ /h	Debi (Q) - Capacity							
		HP	kW	V	A			15	25	35	45	55	65		
	Mono				Tri										
VS-253	2.5" x 2.5"	3	2,2	220	14,9	-	Hm (mSS)	23	22	15	5				
VS-253		3	2,2					-	4,8	23	22	15	5		
VS-254		4	3					-	6.3	31	27	21	10		
VS-324	3" x 2.5"	4	3	380	-	6.3		27	26	23	18	10			
VS-325		5.5	4					-	8.6	34	32	28	23	16	8

TEKNİK ÖZELLİKLER

- Çark: GG-25 Pik döküm
- Gövde: Pik döküm GG-25
- Mil: AISI420 Paslanmaz Çelik
- Eksenel yük dengeleme delikleri ile dengelenir.
- Sızdırmazlık: Mekanik salmastra (Karbon/Seramik/NBR) Ø25
- Sıvı sıcaklığı: +5°C ~ +60°C
- Devir Hızı: 2900d/dak.
- Koruma sınıfı: IP 54
- İzolasyon sınıfı: F
- Emme derinliği: 6.5mt.

TECHNICAL DATA

- Impeller: GG-25 Cast iron
- Pump Body: GG-25 Cast iron
- Shaft: Stainless Steel (AISI420)
- Axial load is reduced by balance holes
- Non-Leakage: Mechanical seal (Carbon/Ceramic/NBR) Ø25
- Liquid Temp.: +5°C ~ +60°C
- Speed: 2900 rpm.
- Protection Class: IP54
- Insulation Class: F
- Suction lift: Max 6.5 m.



KULLANIM ALANLARI

- Temiz su temini
- Tarımsal sulama (Damlama ve Sprink sistemleri)
- Endüstri ve inşaatlar
- Soğutma sistemleri
- Sirkülasyon

APPLICATIONS

- Clean water supply
- Irrigation (Drip and Sprinkler systems)
- Industrial plants, Constructions
- Chiller systems
- Circulation

OPSİYONEL

- Açık Çark
- Bronz Çark
- AISI 316 / AISI 304 Çelik Mil

OPTIONAL

- Open Impeller
- Bronze Impeller
- AISI 316 / AISI 304 S/S Shaft

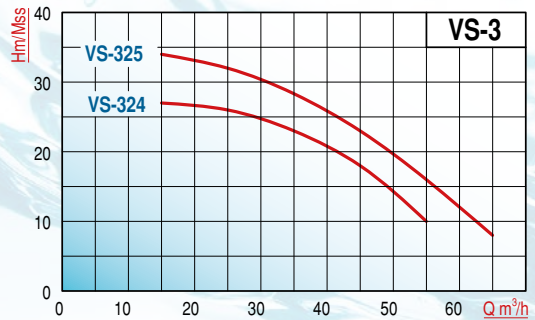
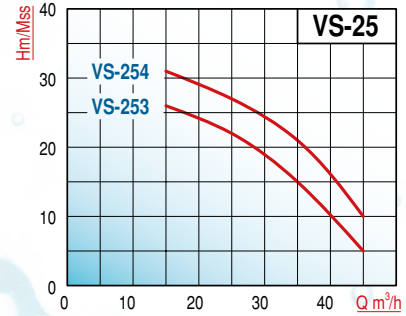
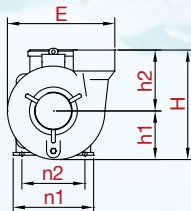
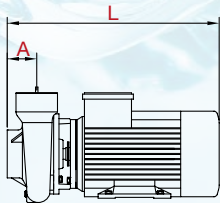

TİP TYPE	Boyutlar - Dimensions (mm)								Ağırlık - Weight
	A	L	h1	h2	H	E	n1	n2	Kg
VS-253	65	440	110	145	255	285	165	140	35
VS-254	65	440	110	145	255	285	165	140	36,5
VS-324	65	500	114	143	257	285	165	140	44,5
VS-325	65	500	114	143	257	285	191	158	46

JET POMPALAR (Kendinden Emişli)

JET PUMPS (Self-priming)

TİP TYPE	Bağlantı Giriş x Çıkış Inlet x Outlet	HP	kW	MOTOR				m ³ /h	Debi (Q) - Capacity				
				V		A			0.5	1	2	3	5
	Mono	Tri	Mono	Tri	H _m (mSS)								
JET100B	1"x1"	1	0.80	220	-	4.8	-	H _m (mSS)	42	39	30	20	
JET180A	1¼"x1"	1.5	1.1	220	-	9	-		60	57	52	45	20
SJET-100C PASLANMAZ JET	1"x1"	1	0.80	220	-	3.8	-		42	38	24		

TEKNİK ÖZELLİKLER

- Çark: Bronz
- Difüzör: PC
- Gövde: Pik döküm GG-25
- Ejektörlü
- Emme derinliği: 8 mt.
- Kendinden emişli (İlk çalıştırmada gövde tamamen su dolu olmalıdır. 2-3dk içerisinde su emilecektir.)
- Mil: Çelik (C1050 Krom kaplı)
- Sızdırmazlık: Mekanik salmastra (Karbon/Seramik/NBR) (JET100, SG): Ø14, JET180: Ø16
- Sıvı sıcaklığı: +5°C ~ +60°C
- Devir Hızı: 2900d/dak.
- Koruma sınıfı: IP 54
- İzolasyon sınıfı: F

KULLANIM ALANLARI

- Temiz su temini
- Hidrofor sistemleri
- Bahçe sulama (Damlama ve Sprink sistemleri)
- Endüstri ve inşaatlar
- Evler

TECHNICAL DATA

- Impeller: Bronz
- Diffuser: PC
- Pump Body: GG-25 Cast iron
- Built-in ejector
- Suction lift: Max 8 m.
- Self-priming (Pump Body should be completely filled with water before first run of the pump, pump will suct within 2-3 min. from. max 8 meters depth)
- Shaft: Steel (C1050 Chrome plated)
- Non-Leakage: Mechanical seal (Carbon/Ceramic/NBR) (JET100, SG): Ø14, JET180: Ø16
- Liquid Temp.: +5°C ~ +60°C
- Speed: 2900 rpm.
- Protection Class: IP54
- Insulation Class: F

APPLICATIONS

- Clean water supply
- Booster systems
- Irrigation (Drip and Sprinkler systems)
- Industry, Constructions
- Residences

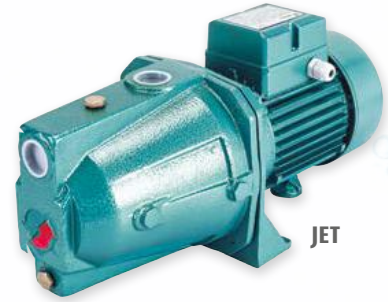

JET



SJET

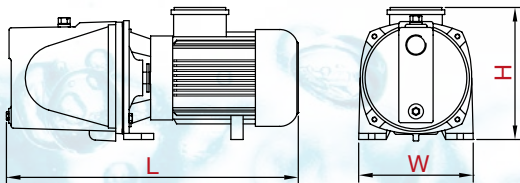

TİP TYPE	Boyutlar - Dimensions (mm)			Ağırlık Weight Kg.
	Boy-L	Yük-H	En-W	
	Length	Height	Width	
JET 100B	445	220	175	15
JET 180A	510	245	210	23
SJET-100A	375	220	195	8

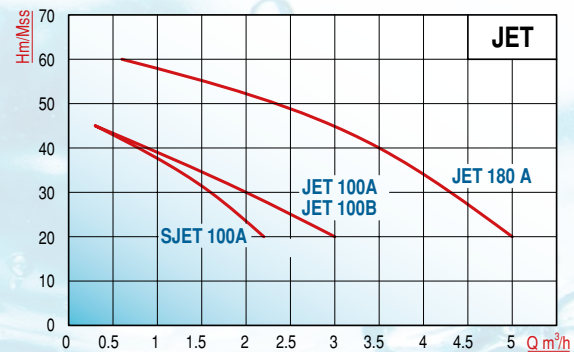

CAS (3000 d/d)

MONOBLOK SALYANGOZ POMPALAR

VOLUTE CASING CLOSE-COUPLED PUMPS

TİP TYPE	Bağlantı Giriş x Çıkış Inlet x Outlet	MOTOR				m ³ /h	Debi (Q) - Capacity					
		HP	kW	V	A		20	30	40	50	60	70
CAS-4	3" x 2.5"	4	3	380	6.3	Hm (mSS)	27	25	20	13	5	
CAS-5.5		5.5	4	380	8.6		31	29	25	19	11	
CAS-7.5		7.5	5.5	380/660	10.3		36	34	31	26	20	
CAS-10		10	7.5	380/660	14.2		46	44	41	35	26	10
CAS-15		15	11	380/660	21		57	55	52	48	40	19
CAS-20		20	15	380/660	28		67	66	63	58	50	28

TEKNİK ÖZELLİKLER

- MOTOR: Yüksek verimli sınıf
- Çark: GG-25 Pik döküm/Bronz (Opsiyonel)
- Gövde: Pik döküm GG-25
- Mil: X20Cr13 (AISI420), Opsiyonel: AISI316 çelik
- Eksenel yük dengeleme delikleri ile dengelenir.
- Flanslar: Giriş DN80 (PN 16) - Çıkış DN65 (PN 40) (Flanslar opsiyoneldir.)
- Sızdırmazlık: Mekanik salmastra (Karbon/Seramik/NBR) Ø25
- Sıvı sıcaklığı: +5°C ~ +60°C
- Devir Hızı: 2900d/dak.
- Koruma sınıfı: IP 54
- İzolasyon sınıfı: F
- Emme derinliği: 6.5mt.

TECHNICAL DATA

- MOTOR: High efficiency class
- Impeller: GG-25 Cast iron /Bronze (Optional)
- Pump Body: GG-25 Cast iron
- Pump Shaft: X20Cr13 (AISI420) steel, Optional: AISI316 stainless steel.
- Axial load is reduced by balance holes
- Flanges: Inlet DN80 (PN 16) Outlet DN65 (PN 40) (Flanges are optional)
- Non-Leakage: Mechanical seal (Carbon/Ceramic/NBR) Ø25
- Liquid Temp.: +5°C ~ +60°C
- Speed: 2900 rpm.
- Protection Class: IP54
- Insulation Class: F
- Suction lift: Max 6.5 m.



KULLANIM ALANLARI

- Temiz su temini
- Tarımsal sulama (Damla ve Sprink sistemleri)
- Buhar kazanları besli,
- Kondens sistemleri
- Endüstri ve İnşaatlar
- Soğutma sistemleri
- Sirkülasyon
- Yangın söndürme

APPLICATIONS

- Clean water supply
- Irrigation (Drip and Sprinkler systems)
- Boiler feeding
- Condens systems
- Industrial plants, Constructions
- Chiller systems
- Circulation
- Fire fighting

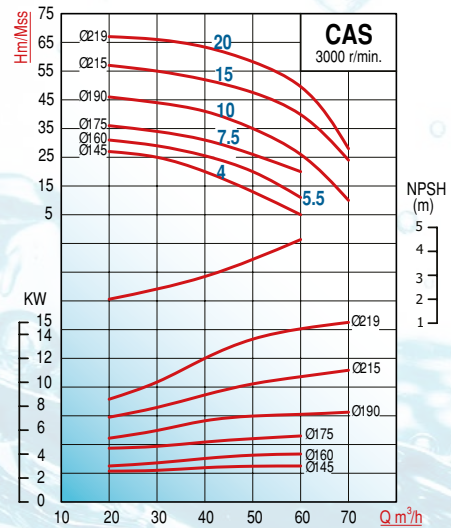
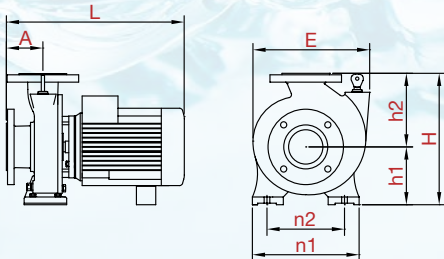

TİP TYPE	Boyutlar - Dimensions (mm)								Ağırlık - Weight	
	A	L	h1	h2	H max	E	n1	n2	Kg	
CAS-4	92	470	165	191	356	280	278	207	61	
CAS-5.5	92	470	165	191	356	280	278	207	63	
CAS-7.5	92	515	165	191	356	280	278	207	71	
CAS-10	92	515	165	191	356	280	278	207	83	
CAS-15	92	570	165	191	356	280	278	207	97	
CAS-20	92	630	165	191	356	280	278	207	100	

CES SERİSİ (3000 d/d & 1500 d/d) (TS EN 733) MONOBLOK SALYANGOZ POMPALAR

VOLUTE CASING CLOSE-COUPLED PUMPS



TEKNİK ÖZELLİKLER

- Motor: IE3 Sınıfı (Yüksek Verimli, Enerji Tasarruflu)
- Kapasite: 15 - 320 m³/h
- Basma Yüksekliği: 15 - 130 m
- Devir Hızı: 3000 d/d, 1500 d/d
- Sıvı Sıcaklığı: -10 °C ~ +105 °C
- Flanşlar TS EN 1092 - 2 / PN 16' ya uygundur.
- Giriş Flanşları: DN65 - DN125
- Çıkış Flanşları: DN 40 - DN100
- İzolasyon sınıfı: F
- Koruma sınıfı: IP55
- Emme derinliği: 6.5m't.
- Pompa Mili IEC ölçülerine uygun Genel maksat tip motorlara geçme şeklinde akuplaj yapılmıştır. Bu şekil akuplaj Pompa ve Motor milinin aynı hızda olmasını sağlar. Böylece çarkın dinamik ve statik olarak dengede çalışması sağlanır.
- Yataklama: Pompa Mili, Arapça denge rulmanı ve motor rulmanları tarafından yataklanır.
- Eksenal yük dengeleme delikleri ile dengelenir.

MALZEME ÖZELLİKLERİ

- Çark: PİK GG-25 PİK Döküm
- Gövde: GG-25 PİK Döküm
- Mil: X20Cr13 (AISI420), Opsiyonel: AISI316 çelik
- Sızdırmazlık: Mekanik salmastra (Karbon-Silisyum/Viton)
- Aşınma Halkası: GG-25 PİK Döküm

KULLANIM ALANLARI

- Temiz su temini
- Endüstriyel tesisler
- Hidrofor sistemleri
- Yangın söndürme sistemleri
- Buhar kazanları besli, kondens sistemleri
- Soğutma sistemleri
- Yağmurlama ve sprinkler sulama
- Sirkülasyon

OPSİYONEL

- Açık Çark
- Bronz Çark
- AISI 316 / AISI 304 Çelik Mil

TECHNICAL DATA

- Motor: IE3 Class (High Efficiency, Energy Saving)
- Capacity: 15 - 320 m³/h
- Total Head: 15 - 130
- Rotation Speed: 3000 rpm, 1500 rpm
- Liquid Temp.: -10°C ~ +105°C
- Suction and discharge flanges conform to EN 1092-2 / PN 16
- Inlet Flanges: DN65 - DN125
- Outlet Flanges: DN40 - DN100
- Insulation Class: F
- Protection Class: IP55
- Suction lift: Max 6.5 m.
- CES series are designed to be driven by IEC standard motor. Pump shaft and motor shaft are close-coupled design. This way of coupling ensures the alignment of pump and motor. Therefore impeller runs in good balance both dynamically and statically.
- Bearing: Pump Shaft is supported by the ball bearing on pump support also by the ball bearings on electric motor.
- Axial load is reduced by balance holes

MATERIAL SPECIFICATIONS

- Impellers: Cast iron GG-25
- Body: Cast iron GG-25
- Pump Shaft: X20Cr13 (AISI420) steel, Optional: AISI316 stainless steel.
- Non-Leakage: Mechanical seal (Carbon -Sic/Viton)
- Wear Ring: Cast iron GG-25

APPLICATIONS

- Clean water supply
- Industry
- Booster systems
- Fire fighting systems
- Boiler feeding, condens systems
- Chiller systems
- Irrigation, sprinkler systems
- Circulation

OPTIONAL

- Open Impeller
- Bronze Impeller
- AISI 316 / AISI 304 S/S Shaft

CES40 (3000 d/d)

MONOBLOK SALYANGOZ POMPALAR

VOLUTE CASING CLOSE-COUPLED PUMPS

TİP TYPE	Bağlantı Giriş x Çıkış Inlet x Outlet	MOTOR						m ³ /h	Debi (Q) - Capacity					
		HP	kW	IEC	V	A	d/d		10	15	20	30	40	50
		CES40-16 04002	2.5"x1.5"	5,5	4	100L	380		8	3000	Hm(mSS)	32	31	29
CES40-16 05502	7,5	5,5		112M	380/660	10,9	40	39	38			34	23	
CES40-16 07502	10	7,5		112M		14,1	48	47	46			44	37	22
CES40-16 11002	15	11		132M		21	53	52	51			49	44	34

TİP TYPE	Bağlantı Giriş x Çıkış Inlet x Outlet	MOTOR						m ³ /h	Debi (Q) - Capacity					
		HP	kW	IEC	V	A	d/d		15	25	35	40	45	50
		CES40-20 04002	2.5"x1.5"	5,5	4	100L	380		8	3000	Hm (mSS)	37	20	5
CES40-20 05502	7,5	5,5		112M	380/660	10,9	44	35	20			15		
CES40-20 07502	10	7,5		112M		14,1	49	46	40			34	24	
CES40-20 11002	15	11		132M		21	58	57	53			50	45	38
CES40-20 15002	20	15		160L		28	69	68	66			64	60	54

TİP TYPE	Bağlantı Giriş x Çıkış Inlet x Outlet	MOTOR						m ³ /h	Debi (Q) - Capacity					
		HP	kW	IEC	V	A	d/d		10	20	30	40	50	60
		CES40-26 15002	2.5"x1.5"	20	15	160L	380/660		28	3000	Hm (mSS)	70	68	63
CES40-26 18502	25	18,5		160L	34	78		76	71			65	59	51
CES40-26 22002	30	22		160L	40,5	90		88	83			76	69	60
CES40-26 30002	40	30		200L	54.6	98		97	93			87	80	71

TİP TYPE	Bağlantı Giriş x Çıkış Inlet x Outlet	MOTOR						m ³ /h	Debi (Q) - Capacity					
		HP	kW	IEC	V	A	d/d		10	20	30	35	40	50
		CES40-32 30002	2.5"x1.5"	40	30	200L	380/660		54.6	3000	Hm (mSS)	105	103	99
CES40-32 37002	50	37		200L	68	130		129	124			121	118	110
CES40-32 45002	60	45		200L	83,8	143		142	137			134	131	123



CES40 (3000 d/d) MONOBLOK SALYANGOZ POMPALAR

VOLUTE CASING CLOSE-COUPLED PUMPS

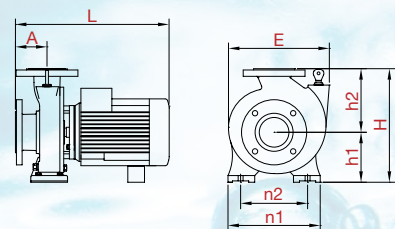
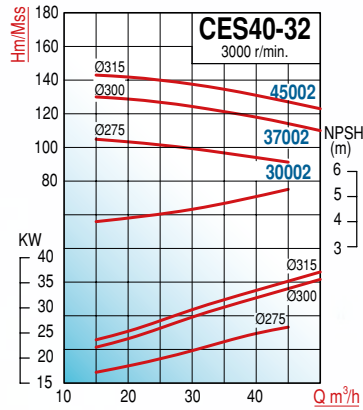
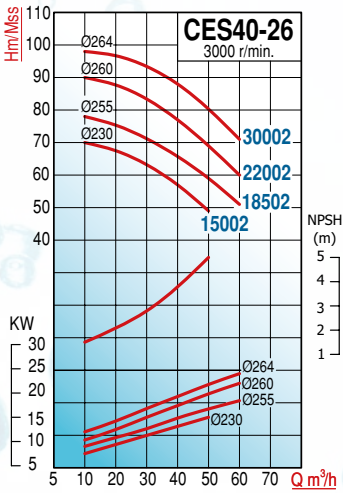
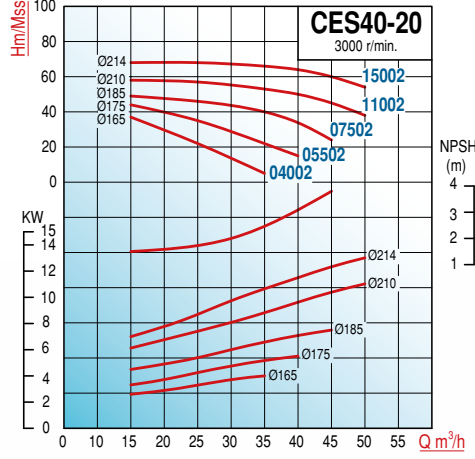
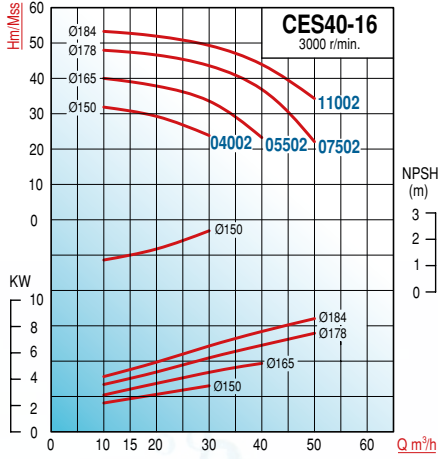

TİP TYPE	Boyutlar - Dimensions (mm)								Ağırlık - Weight
	A	L	h1	h2	H	E	n1	n2	Kg
CES40-16 04002	80	549	132	160	292	246	240	190	50
CES40-16 05502	80	568	132	160	292	246	240	190	56
CES40-16 07502	80	568	132	160	292	246	240	190	56
CES40-16 11002	80	721	132	160	292	246	240	190	81
CES40-20 04002	100	608	160	180	340	276	265	212	61
CES40-20 05502	100	651	160	180	340	276	265	212	65
CES40-20 07502	100	651	160	180	340	276	265	212	71
CES40-20 11002	100	713	160	180	340	276	265	212	92
CES40-20 15002	100	779	160	180	380	350	265	212	132
CES40-26 15002	100	794	180	225	405	350	320	250	144
CES40-26 18502	100	794	180	225	405	350	320	250	159
CES40-26 22002	100	794	180	225	405	350	320	250	158
CES40-26 30002	100	885	180	225	461	400	320	250	208
CES40-32 30002	125	908	200	250	461	400	345	280	231
CES40-32 37002	125	908	200	250	461	400	345	280	250
CES40-32 45002	125	908	200	250	461	400	345	280	287

CE50 (3000 d/d) MONOBLOK SALYANGOZ POMPALAR

VOLUTE CASING CLOSE-COUPLED PUMPS

TİP TYPE	Bağlantı Giriş x Çıkış Inlet x Outlet	MOTOR						m ³ /h Hm (mSS)	Debi (Q) - Capacity					
		HP	kW	IEC	V	A	d/d		20	30	40	50	60	70
		CE50-16 05502	2.5" x 2"	7,5	5,5	112M	380/660		10,9	3000	Hm (mSS)	29	28	26
CE50-16 07502	10	7,5		112M	14,1	37		36	34			31	26	
CE50-16 11002	15	11		132M	21	47		47	45			42	39	35

TİP TYPE	Bağlantı Giriş x Çıkış Inlet x Outlet	MOTOR						m ³ /h Hm (mSS)	Debi (Q) - Capacity					
		HP	kW	IEC	V	A	d/d		30	40	50	60	75	90
		CE50-20 11002	2.5" x 2"	15	11	132M	380/660		21	3000	Hm (mSS)	46	45	43
CE50-20 15002	20	15		160L	28	54		53	51			48	42	34
CE50-20 18502	25	18.5		160L	34	61		60	59			56	51	43
CE50-20 22002	30	22		160L	40.5	66		65	64			62	57	50

TİP TYPE	Bağlantı Giriş x Çıkış Inlet x Outlet	MOTOR						m ³ /h Hm (mSS)	Debi (Q) - Capacity					
		HP	kW	IEC	V	A	d/d		30	40	55	70	85	105
		CE50-26 18502	2.5" x 2"	25	18.5	160L	380/660		34	3000	Hm (mSS)	67	65	60
CE50-26 22002	30	22		160L	40,5	75		73	68			62	53	
CE50-26 30002	40	30		200L	54,6	93		91	86			79	70	55
CE50-26 37002	50	37		200L	68	101		99	94			87	79	64

TİP TYPE	Bağlantı Giriş x Çıkış Inlet x Outlet	MOTOR						m ³ /h Hm (mSS)	Debi (Q) - Capacity					
		HP	kW	IEC	V	A	d/d		30	45	60	75	90	105
		CE50-32 30002	2.5"x2"	40	30	200L	380/660		54,6	3000	Hm (mSS)	88	87	83
CE50-32 37002	50	37		200L	68	99		98	95			87	68	
CE50-32 45002	60	45		200L	83,8	112		111	107			99	84	52



CES50 (3000 d/d) MONOBLOK SALYANGOZ POMPALAR

VOLUTE CASING CLOSE-COUPLED PUMPS

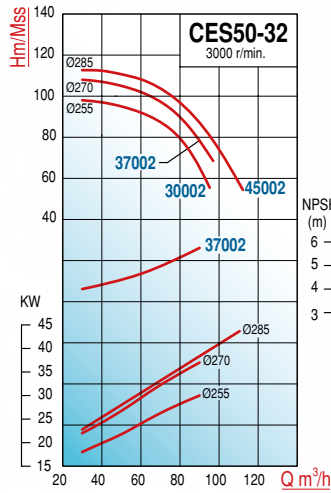
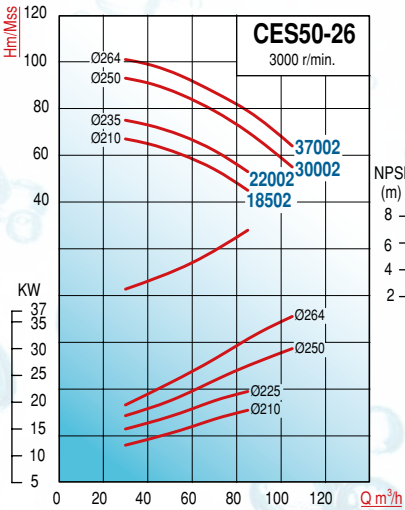
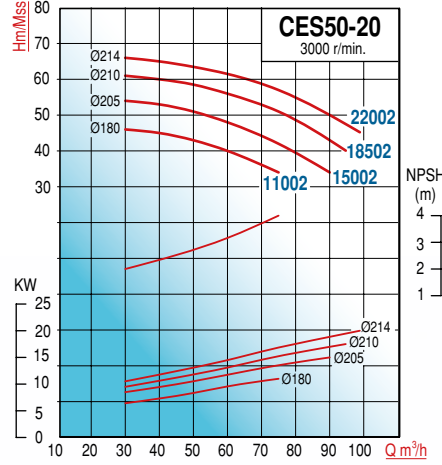
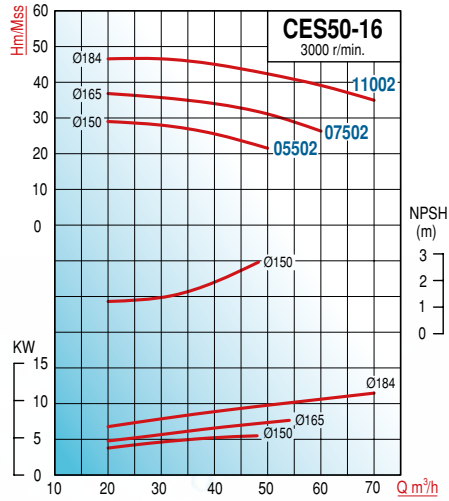

TİP TYPE	Boyutlar - Dimensions (mm)								Ağırlık - Weight
	A	L	h1	h2	H	E	n1	n2	Kg
CES50-16 05502	100	589	160	180	340	271	265	212	61
CES50-16 07502	100	589	160	180	340	271	265	212	61
CES50-16 11002	100	748	160	180	340	271	265	212	88
CES50-20 11002	100	718	160	200	360	307	265	212	99
CES50-20 15002	100	784	160	200	360	350	265	212	136
CES50-20 18502	100	784	160	200	360	350	265	212	151
CES50-20 22002	100	784	160	200	360	350	265	212	150
CES50-26 18502	100	796	180	225	405	350	320	250	162
CES50-26 22002	100	796	180	225	405	350	320	250	161
CES50-26 30002	100	887	180	225	461	400	320	250	212
CES50-26 37002	100	887	180	225	461	400	320	250	231
CES50-32 30002	125	912	225	280	505	417	345	280	235
CES50-32 37002	125	912	225	280	505	417	345	280	254
CES50-32 45002	125	912	225	280	505	417	345	280	287

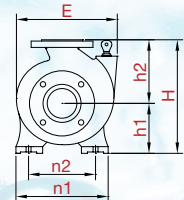
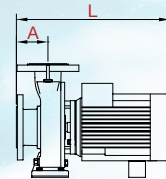

CES65 (3000 d/d)

MONOBLOK SALYANGOZ POMPALAR

VOLUTE CASING CLOSE-COUPLED PUMPS

TİP TYPE	Bağlantı Giriş x Çıkış Inlet x Outlet	MOTOR						m ³ /h	Debi (Q) - Capacity					
		HP	kW	IEC	V	A	d/d		20	45	90	115	120	130
		CES65-13 04002	3" x 2.5"	5,5	4	100L	380		8	3000	Hm (mSS)	15	13	9
CES65-13 05502	7.5	5,5		112M	380/660	10.9	18	16	12			7	5	1
CES65-13 07502	10	7.5		112M		14.1	21	20	16			11	9	2
CES65-13 11002	15	11		132M		21	24	23	20			15	13	6

TİP TYPE	Bağlantı Giriş x Çıkış Inlet x Outlet	MOTOR						m ³ /h	Debi (Q) - Capacity					
		HP	kW	IEC	V	A	d/d		30	60	90	110	125	140
		CES65-16 07502	3" x2.5"	10	7.5	112M	380/660		14.1	3000	Hm (mSS)	30	26	18
CES65-16 11002	15	11		132M	21	36		33	26			22	17	5
CES65-16 15002	20	15		160L	28	42		38	33			27	22	16

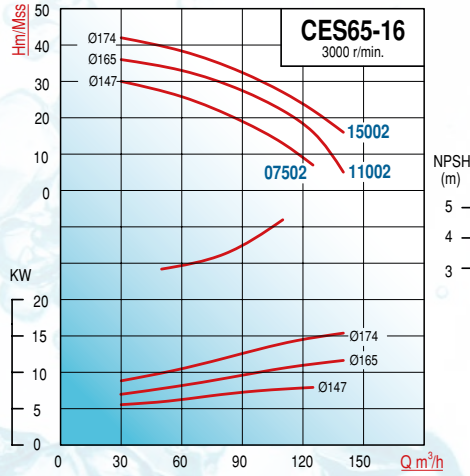
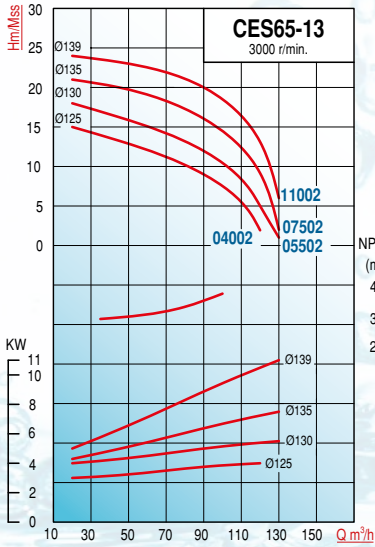

TİP TYPE	Boyutlar - Dimensions (mm)								Ağırlık - Weight
	A	L	h1	h2	H	E	n1	n2	Kg
CES65-13 04002	100	575	160	180	340	284	280	212	58
CES65-13 05502	100	575	160	180	340	284	280	212	64
CES65-13 07502	100	620	160	180	340	284	280	212	69
CES65-13 11002	100	681	160	180	340	284	280	212	87
CES65-16 07502	100	649	160	200	360	295	280	212	73
CES65-16 11002	100	709	160	200	360	295	280	212	94
CES65-16 15002	100	777	160	200	380	350	280	212	131

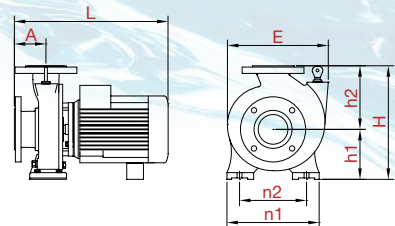

CES65 (3000 d/d)

MONOBLOK SALYANGOZ POMPALAR

VOLUTE CASING CLOSE-COUPLED PUMPS

TİP TYPE	Bağlantı Giriş x Çıkış Inlet x Outlet	MOTOR						m ³ /h	Debi (Q) - Capacity					
		HP	kW	IEC	V	A	d/d		80	100	125	140	150	155
CES65-20 15002	3" x 2.5"	20	15	160L	380/660	28	3000	Hm (mss)	33	31	27	20	11	2
CES65-20 18502		25	18,5	160L		34			44	40	34	28	22	15
CES65-20 22002		30	22	160L		40,5			48	44	38	32	26	17
CES65-20 30002		40	30	200L		56,6			57	53	48	43	36	25
CES65-20 37002		50	37	200L		68			63	61	56	50	44	31

TİP TYPE	Bağlantı Giriş x Çıkış Inlet x Outlet	MOTOR						m ³ /h	Debi (Q) - Capacity					
		HP	kW	IEC	V	A	d/d		30	50	125	150	155	160
CES65-26 22002	3" x 2.5"	30	22	160L	380/660	40,5	3000	Hm (mss)	59	58	43	25	17	2
CES65-26 30002		40	30	200L		54,6			65	64	52	39	32	12
CES65-26 37002		50	37	200L		68			81	80	67	55	50	40
CES65-26 45002		60	45	200L		83,8			91	90	88	72	66	60

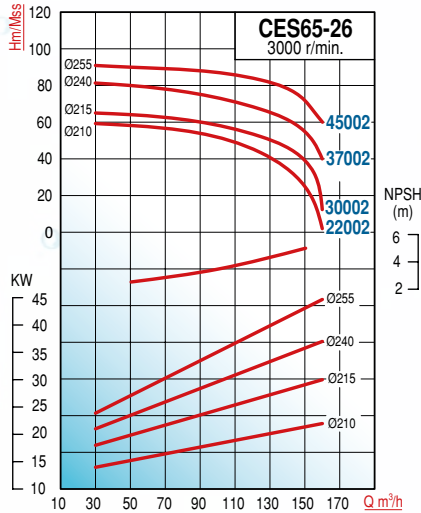
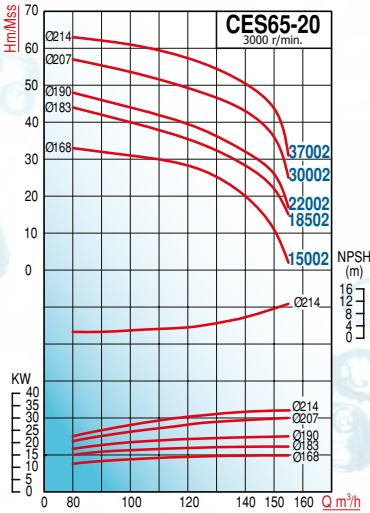

TİP TYPE	Boyutlar - Dimensions (mm)								Ağırlık - Weight
	A	L	h1	h2	H	E	n1	n2	Kg
CES65-20 15002	100	785	180	225	405	350	320	250	144
CES65-20 18502	100	785	180	225	405	350	320	250	159
CES65-20 22002	100	785	180	225	405	350	320	250	158
CES65-20 30002	100	867	180	225	461	400	320	250	210
CES65-20 37002	100	917	180	225	461	400	320	250	239
CES65-26 22002	100	756	200	250	450	354	360	280	169
CES65-26 30002	100	887	200	250	461	400	360	280	220
CES65-26 37002	100	887	200	250	461	400	360	280	220
CES65-26 45002	100	887	200	250	461	400	360	280	253

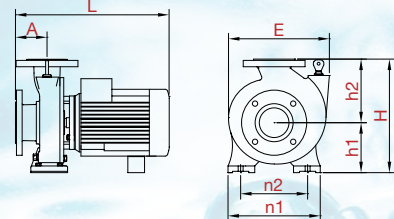

CES80 (3000 d/d)

MONOBLOK SALYANGOZ POMPALAR

VOLUTE CASING CLOSE-COUPLED PUMPS

TİP TYPE	Bağlantı	MOTOR						m ³ /h	Debi (Q) - Capacity						
	Giriş x Çıkış	HP	kW	IEC	V	A	d/d		Hm (mSS)	70	100	130	160	190	220
	Inlet x Outlet														
CES80-16 11002	4" x 3"	15	11	132M	380/660	21	3000	Hm (mSS)	26	25	23	19	13		
CES80-16 15002		20	15	160L		26.7			30	29	28	25	20	13	
CES80-16 18502		25	18.5	160L		32.6			34	33	32	29	25	18	
CES80-16 22002		30	22	160L		40,5			38	37	36	33	29	23	

TİP TYPE	Bağlantı	MOTOR						m ³ /h	Debi (Q) - Capacity						
	Giriş x Çıkış	HP	kW	IEC	V	A	d/d		Hm (mSS)	90	120	150	180	210	240
	Inlet x Outlet														
CES80-20 18502	4" x 3"	25	18.5	160L	380/660	32.6	3000	Hm (mSS)	41	39	35	29	20		
CES80-20 22002		30	22	160L		40,5			47	46	44	40	33		
CES80-20 30002		40	30	200L		54.6			53	52	50	46	40	32	
CES80-20 37002		50	37	200L		67.5			58	57	55	52	47	40	
CES80-20 45002		60	45	200L		83,8			64	63	62	59	54	46	

TİP TYPE	Bağlantı	MOTOR						m ³ /h	Debi (Q) - Capacity						
	Giriş x Çıkış	HP	kW	IEC	V	A	d/d		Hm (mSS)	70	100	130	160	190	220
	Inlet x Outlet														
CES80-26 30002	4" x 3"	40	30	200L	380/660	54.6	3000	Hm (mSS)	59	58	55	50	41	25	
CES80-26 37002		50	37	200L		68			64	63	61	57	49	35	
CES80-26 45002		60	45	200L		83,8			70	69	67	63	57	48	

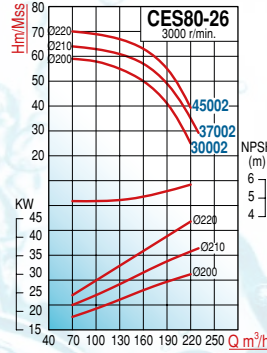
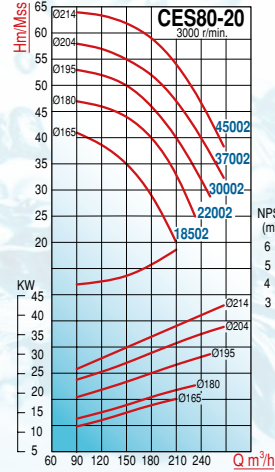
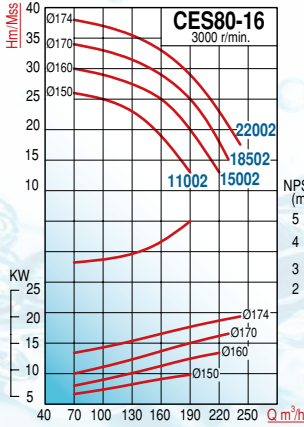

TİP TYPE	Boyutlar - Dimensions (mm)								Ağırlık - Weight
	A	L	h1	h2	H	E	n1	n2	Kg
CES80-16 11002	125	785	180	225	405	350	320	250	144
CES80-16 15002	125	785	180	225	405	350	320	250	159
CES80-16 18502	125	785	180	225	405	350	320	250	158
CES80-16 22002	125	867	180	225	461	400	320	250	210
CES80-16 30002	125	756	200	250	450	354	360	280	169
CES80-20 18502	125	887	200	250	461	400	360	280	220
CES80-20 22002	125	887	200	250	461	400	360	280	220
CES80-20 30002	125	887	200	250	461	400	360	280	220
CES80-20 37002	125	887	200	250	461	400	360	280	220
CES80-20 45002	125	887	200	250	461	400	360	280	253
CES80-26 30002	125	887	200	250	461	400	360	280	220
CES80-26 37002	125	887	200	250	461	400	360	280	220
CES80-26 45002	125	887	200	250	461	400	360	280	253

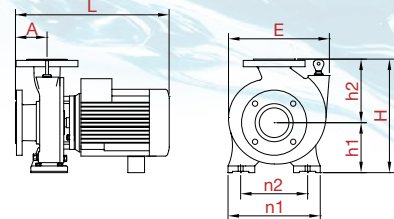

CES100 (3000 d/d)

MONOBLOK SALYANGOZ POMPALAR

VOLUTE CASING CLOSE-COUPLED PUMPS

TİP TYPE	Bağlantı Giriş x Çıkış Inlet x Outlet	MOTOR						Hm mSS	Debi (Q) - Capacity						
		HP	kW	IEC	V	A	p/d		m ³ /h	120	160	200	240	280	320
										43	41	38	34.5	30	24
CES100-20 30002	5" x 4"	40	30	200L	380/660	54.6	3000	Hm (mSS)	43	41	38	34.5	30	24	
CES100-20 37002		50	37	200L		67.5			49	47	44	40.5	36	30	
CES100-20 45002		60	45	200L		83.8			55	53	51	47	42	35	

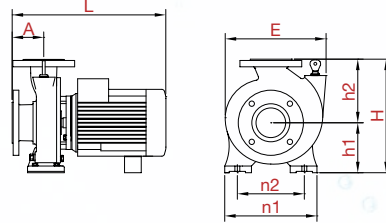
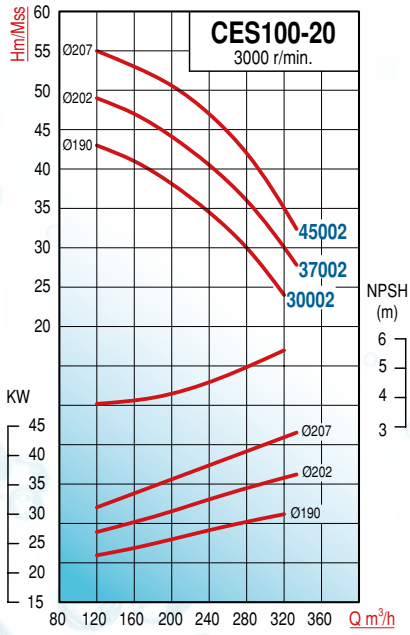

TİP TYPE	Boyutlar - Dimensions (mm)								Ağırlık - Weight
	A	L	h1	h2	H	E	n1	n2	Kg
CES100-20 30002	125	904	200	280	480	400	360	280	224
CES100-20 37002	125	904	200	280	480	400	360	280	224
CES100-20 45002	125	904	200	280	480	400	360	280	257

CES40 (1500 d/d) MONOBLOK SALYANGOZ POMPALAR

1500 d/d

VOLUTE CASING CLOSE-COUPLED PUMPS

TİP TYPE	Bağlantı	MOTOR						m ³ /h	Debi (Q) - Capacity						
	Giriş x Çıkış	HP	kW	IEC	V	A	d/d		m ³ /h	Debi (Q) - Capacity					
	Inlet x Outlet									4	8	12	15	18	23
CES40-16 00554	2.5"x1.5"	0,75	0,55	80M	380	1,45	1500	Hm (mSS)	8,5	8	7,5	6,5	2		
CES40-16 00754		1	0,75	80M		1,9			11	10,5	10	9	8	3	
CES40-16 01104		1,5	1,1	80M		2,6			12,5	12	11,5	11	10,5	8,5	

TİP TYPE	Bağlantı	MOTOR						m ³ /h	Debi (Q) - Capacity						
	Giriş x Çıkış	HP	kW	IEC	V	A	d/d		m ³ /h	Debi (Q) - Capacity					
	Inlet x Outlet									8	12	14	16	18	20
CES40-20 00754	2.5"x1.5"	1	0,75	80M	380	1,9	1500	Hm (mSS)	10	9,5	9	8	7		
CES40-20 01104		1,5	1,1	80M		2,6			13,5	13	12,5	11,5	10,5	9	
CES40-20 01504		2	1,5	90L		3,5			16	15,5	15	14	13	11,5	

TİP TYPE	Bağlantı	MOTOR						m ³ /h	Debi (Q) - Capacity						
	Giriş x Çıkış	HP	kW	IEC	V	A	d/d		m ³ /h	Debi (Q) - Capacity					
	Inlet x Outlet									9	12	15	18	23	25
CES40-26 01104	2.5"x1.5"	1,5	1,1	80M	380	1,9	1500	Hm (mSS)	12	11,5	11	10			
CES40-26 01504		2	1,5	90L		3,5			16	15	14,5	13,5	11		
CES40-26 02204		3	2,2	90L		4,8			20	19,5	19	18	15,5		
CES40-26 03004		4	3	100L		6,6			24,5	24	23,5	22,5	19,5	18	

TİP TYPE	Bağlantı	MOTOR						m ³ /h	Debi (Q) - Capacity						
	Giriş x Çıkış	HP	kW	IEC	V	A	d/d		m ³ /h	Debi (Q) - Capacity					
	Inlet x Outlet									10	14	18	22	26	30
CES40-32 02204	2.5"x1.5"	3	2,2	90L	380	5,1	1500	Hm (mSS)	20	19	17	14			
CES40-32 03004		4	3	100L		6,6			26	25	23	20,5	16		
CES40-32 04004		5,5	4	100L	380/660	8,3			31	30	28,5	26	23	17	
CES40-32 05504		7,5	5,5	112M		14,1			38	37	35	32	28	23	



CES40 (1500 d/d)

MONOBLOK SALYANGOZ POMPALAR

VOLUTE CASING CLOSE-COUPLED PUMPS

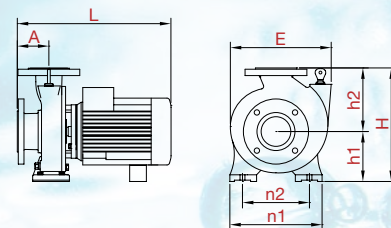
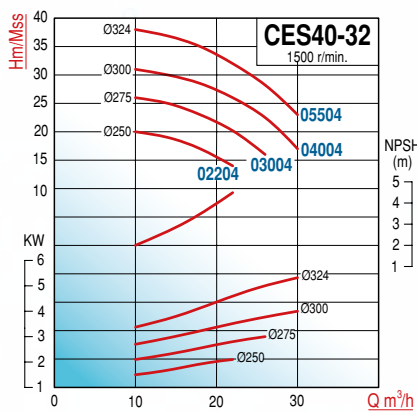
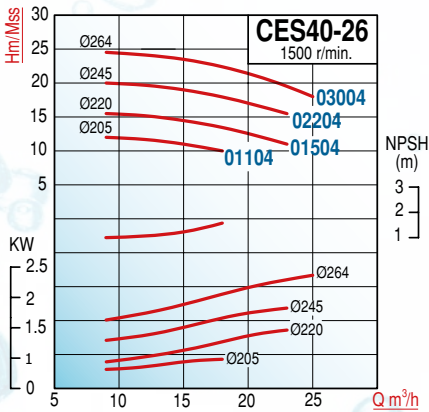
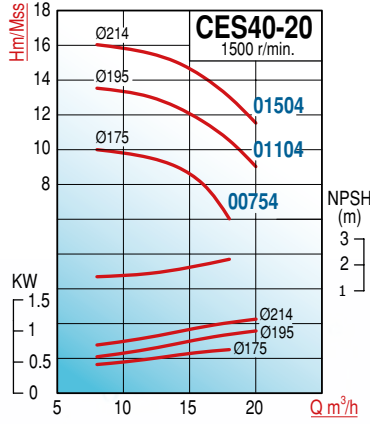
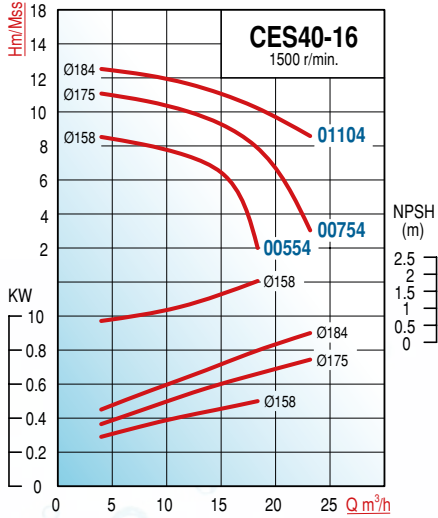
1500 d/d

TİP TYPE	Boyutlar - Dimensions (mm)							
	A	h1	h2	H	E	n1	n2	L
CES40-16 00554	80	132	160	292	246	240	190	472
CES40-16 00754	80	132	160	292	246	240	190	472
CES40-16 01104	80	132	160	292	246	240	190	472
CES40-20 00754	100	160	175	340	277	265	212	486
CES40-20 01104	100	160	175	340	277	265	212	486
CES40-20 01504	100	160	175	340	277	265	212	509
CES40-26 01104	100	180	225	405	350	320	250	487
CES40-26 01504	100	180	225	405	350	320	250	510
CES40-26 02204	100	180	225	405	350	320	250	539
CES40-26 03004	100	180	225	405	350	320	250	535
CES40-32 02204	125	200	250	461	400	345	280	593
CES40-32 03004	125	200	250	461	400	345	280	593
CES40-32 04004	125	200	250	461	400	345	280	621
CES40-32 05504	125	200	250	461	400	345	280	668

CESS50 (1500 d/d) MONOBLOK SALYANGOZ POMPALAR

1500 d/d

VOLUTE CASING CLOSE-COUPLED PUMPS

TİP TYPE	Bağlantı Giriş x Çıkış Inlet x Outlet	MOTOR						d/d	m ³ /h	Debi (Q) - Capacity					
		HP	kW	IEC	V	A	Hm (mSS)			5	10	15	20	25	30
		CESS50-16 00754	1	0,75	80M	380				1,9	1500	Hm (mSS)	8,5	8	8
CESS50-16 01104	1,5	1,1	90L	2,6	10		10	9,5	9	8,5			7,5		
CESS50-16 01504	2	1,5	90L	3,5	11,5		11,5	11	10,5	9,5			9		

TİP TYPE	Bağlantı Giriş x Çıkış Inlet x Outlet	MOTOR						d/d	m ³ /h	Debi (Q) - Capacity					
		HP	kW	IEC	V	A	Hm (mSS)			15	20	25	30	35	40
		CESS50-20 01104	1,5	1,1	90L	380				2,6	1500	Hm (mSS)	10,5	10	9
CESS50-20 01504	2	1,5	90L	3,5	12,5		12	11,5	10,5	9,5					
CESS50-20 02204	3	2,2	90L	5,1	15		14,5	14	13,5	12,5			11		

TİP TYPE	Bağlantı Giriş x Çıkış Inlet x Outlet	MOTOR						d/d	m ³ /h	Debi (Q) - Capacity					
		HP	kW	IEC	V	A	Hm (mSS)			15	25	30	35	40	50
		CESS50-26 02204	3	2,2	90L	380				4,8	1500	Hm (mSS)	15,5	14,5	13
CESS50-26 03004	4	3	100L	6,6	19,5		19	18	16,5	14,5					
CESS50-26 04004	5,5	4	100L	380/ 660	8,3	22,5	22	21,5	21	20			17		
CESS50-26 05504	7,5	5,5	112M		14,1	24,5	24	23,5	23	22			19		

TİP TYPE	Bağlantı Giriş x Çıkış Inlet x Outlet	MOTOR						d/d	m ³ /h	Debi (Q) - Capacity					
		HP	kW	IEC	V	A	Hm (mSS)			15	25	35	45	55	65
		CESS50-32 04004	5,5	4	100L	380/ 660				8,3	1500	Hm (mSS)	25	24	22
CESS50-32 05504	7,5	5,5	112M	14,1	29		28	26,5	24	21					
CESS50-32 07504	10	7,5	132M	15,7	34		33	31	29	26			22		
CESS50-32 11004	15	11	132M	21,6	37		36	34,5	32	29,5			25		



CES50 (1500 d/d) MONOBLOK SALYANGOZ POMPALAR

1500 d/d

VOLUTE CASING CLOSE-COUPLED PUMPS

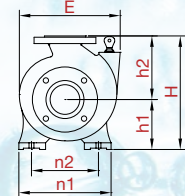
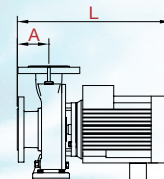
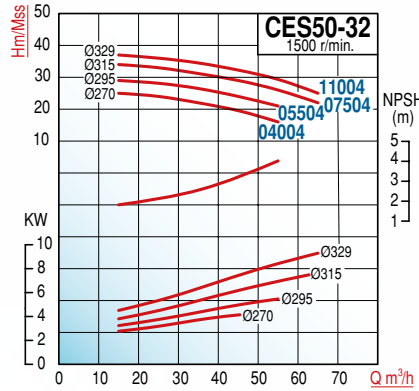
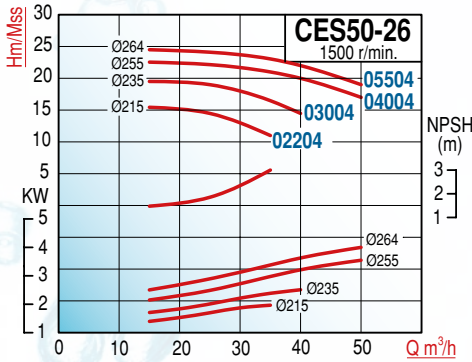
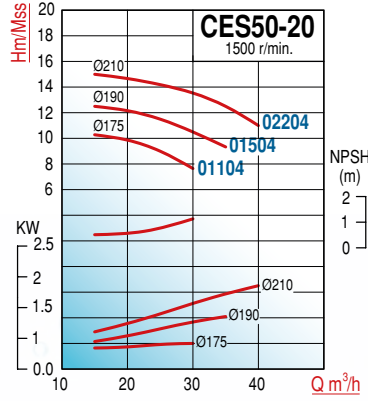
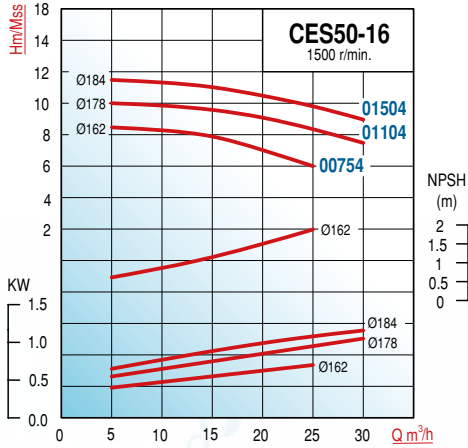

TİP TYPE	Boyutlar - Dimensions (mm)							
	A	h1	h2	H	E	n1	n2	L
CES50-16 00754	100	160	180	340	271	265	212	513
CES50-16 01104	100	160	180	340	271	265	212	513
CES50-16 01504	100	160	180	340	271	265	212	554
CES50-20 01104	100	160	200	360	303	265	212	490
CES50-20 01504	100	160	200	360	303	265	212	513
CES50-20 02204	100	160	200	360	303	265	212	541
CES50-20 02204	100	180	225	405	350	320	250	540
CES50-26 03004	100	180	225	405	350	320	250	536
CES50-26 04004	100	180	225	405	350	320	250	564
CES50-26 05504	100	180	225	405	350	320	250	611
CES50-32 04004	125	225	280	505	417	345	280	624
CES50-32 05504	125	225	280	505	417	345	280	671
CES50-32 07504	125	225	280	505	417	345	280	692
CES50-32 11004	125	225	280	505	417	345	280	719

CES65 (1500 d/d)

MONOBLOK SALYANGOZ POMPALAR

1500 d/d

VOLUTE CASING CLOSE-COUPLED PUMPS

TİP TYPE	Bağlantı Giriş x Çıkış Inlet x Outlet	MOTOR						d/d	m ³ /h	Debi (Q) - Capacity					
		HP	kW	IEC	V	A	15			30	45	60	75	90	
		CES65-20 01504	3"x2.5"	2	1,5	90L	380			3,5	1500	Hm (mSS)	9	8,5	7
CES65-20 02204	3	2,2		90L	5,1	11		10,5	9,5	7,5					
CES65-20 03004	4	3		100L	6,6	14		13,5	12,5	11			8,5		
CES65-20 04004	5,5	4		100L	380/660	8,3	16	15,5	14,5	13			11	8	

TİP TYPE	Bağlantı Giriş x Çıkış Inlet x Outlet	MOTOR						d/d	m ³ /h	Debi (Q) - Capacity					
		HP	kW	IEC	V	A	20			35	45	55	65	75	
		CES65-26 03004	3"x2.5"	4	3	100L	380/			6,6	1500	Hm (mSS)	16	15,5	14,5
CES65-26 04004	5,5	4		100L	660	8,3		19,5	19	17,5			16	14	
CES65-26 05504	7,5	5,5		112M	14,1	22,5	22	21	20	19			17,5		
CES65-26 07504	10	7,5		132M	15,7	25	24,5	24	23	22			20		

TİP TYPE	Bağlantı Giriş x Çıkış Inlet x Outlet	MOTOR						d/d	m ³ /h	Debi (Q) - Capacity					
		HP	kW	IEC	V	A	30			45	60	75	90	105	
		CES65-32 05504	3"x2.5"	7,5	5,5	112M	380/			14,1	1500	Hm (mSS)	22	21	19
CES65-32 07504	10	7,5		132M	660	15,7		27,5	27	25,5			22,5	15	
CES65-32 11004	15	11		132M	22,8	34	33	31	28	22,5			13		
CES65-32 15004	15	20		132M	29,8	37,5	36,5	35	32,5	27,5			20		

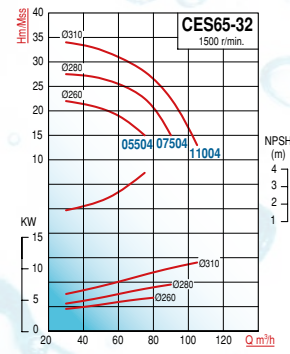
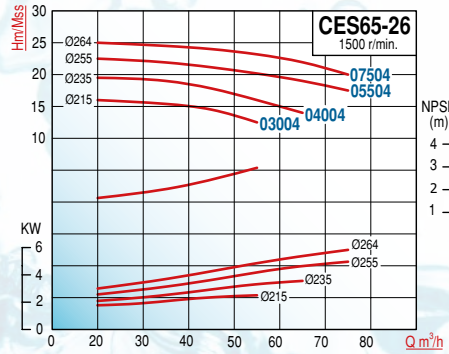
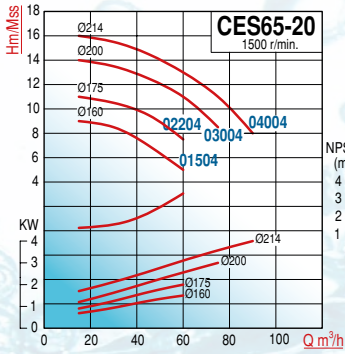

TİP TYPE	Boyutlar - Dimensions (mm)							
	A	h1	h2	H	E	n1	n2	L
CES65-20 01504	100	180	225	405	320	320	250	517
CES65-20 02204	100	180	225	405	320	320	250	545
CES65-20 03004	100	180	225	405	320	320	250	542
CES65-20 04004	100	180	225	405	320	320	250	586
CES65-26 03004	100	200	250	450	354	360	280	535
CES65-26 04004	100	200	250	450	354	360	280	563
CES65-26 05504	100	200	250	450	354	360	280	610
CES65-26 07504	100	200	250	450	354	360	280	665
CES65-32 05504	125	225	280	505	415	400	315	679
CES65-32 07504	125	225	280	505	415	400	315	708
CES65-32 11004	125	225	280	505	415	400	315	735

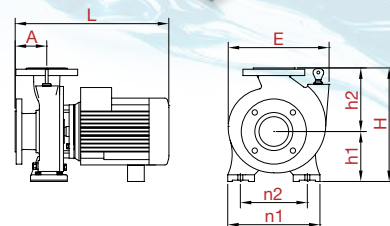

CES80 (1500 d/d) MONOBLOK SALYANGOZ POMPALAR

VOLUTE CASING CLOSE-COUPLED PUMPS

1500 d/d

TİP TYPE	Bağlantı Giriş x Çıkış Inlet x Outlet	MOTOR						d/d	m ³ /h	Debi (Q) - Capacity					
		HP	kW	IEC	V	A	40			55	70	85	100	115	
		CES80-20 03004	4"x3"	4	3	100L	380			6,6	1500	Hm (mSS)	11	10,5	10
CES80-20 04004	5,5	4		100L	380/	8,3	13	12,5	12	11,5			10,5		
CES80-20 05504	7,5	5,5		112M	660	14,1	15,5	15	14,5	14			13	12	

TİP TYPE	Bağlantı Giriş x Çıkış Inlet x Outlet	MOTOR						d/d	m ³ /h	Debi (Q) - Capacity					
		HP	kW	IEC	V	A	40			60	80	100	115	130	
		CES80-26 04004	4"x3"	5,5	4	100L	380/ 660			8,3	1500	Hm (mSS)	15	14,5	13,5
CES80-26 05504	7,5	5,5		112M	11,4	17,5		17	16	15			13		
CES80-26 07504	10	7,5		132M	15,7	21,5		21	20	18,5			16,5	14	
CES80-26 11004	15	11		132M	21,6	24,5		24	23,5	22			20,5	18,5	

TİP TYPE	Bağlantı Giriş x Çıkış Inlet x Outlet	MOTOR						d/d	m ³ /h	Debi (Q) - Capacity					
		HP	kW	IEC	V	A	40			60	80	100	130	160	
		CES80-32 07504	4"x3"	10	7,5	132M	380/ 660			15,7	1500	Hm (mSS)	23	22	20
CES80-32 11004	15	11		132M	21,6	30		29	27	25			19		
CES80-32 15004	20	15		160L	29,8	35		34	33	31			27	21	
CES80-32 18504	25	18,5		160L	35,8	37,5		37	36	35			32	26	

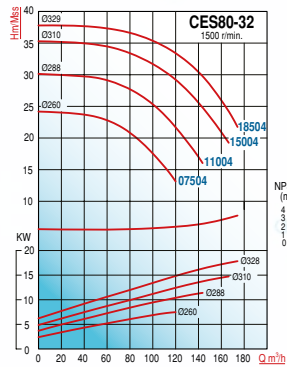
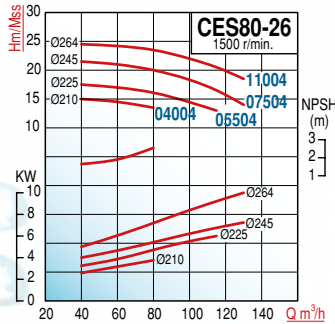
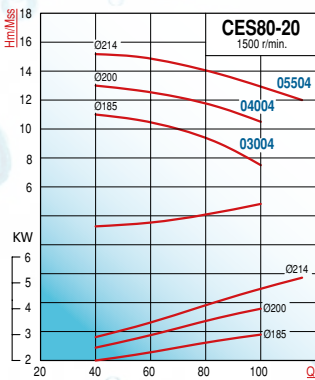

TİP TYPE	Boyutlar - Dimensions (mm)							
	A	h1	h2	H	E	n1	n2	L
CES80-20 03004	125	180	250	430	385	345	280	567
CES80-20 04004	125	180	250	430	385	345	280	611
CES80-20 05504	125	180	250	430	385	345	280	611
CES80-26 04004	125	200	280	480	420	400	315	589
CES80-26 05504	125	200	280	480	420	400	315	636
CES80-26 07504	125	200	280	480	420	400	315	691
CES80-26 11004	125	200	280	480	420	400	315	718
CES80-32 07504	125	250	315	565	445	400	315	717
CES80-32 11004	125	250	315	565	445	400	315	717
CES80-32 15004	125	250	315	565	445	400	315	821
CES80-32 18504	125	250	315	565	445	400	315	874

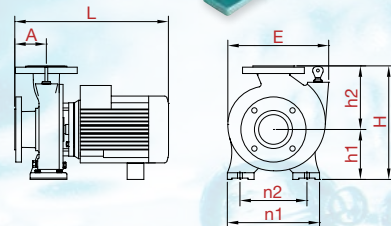

CES100 (1500 d/d)

MONOBLOK SALYANGOZ POMPALAR

1500 d/d

VOLUTE CASING CLOSE-COUPLED PUMPS

TİP TYPE	Bağlantı	MOTOR						m ³ /h	Debi (Q) - Capacity						
	Giriş x Çıkış	HP	kW	IEC	V	A	d/d		Hm (mSS)	50	80	110	140	160	180
	Inlet x Outlet														
CES100-20 03004	5"x4"	4	3	100L	380	6,6	1500	Hm (mSS)		9,5	9	8	6,5		
CES100-20 04004		5,5	4	100L	380/	8,3			12	11,5	10,5	8,5	7		
CES100-20 05504		7,5	5,5	112M	660	14,1			14	13,5	13	11,5	10	8,5	

TİP TYPE	Bağlantı	MOTOR						m ³ /h	Debi (Q) - Capacity						
	Giriş x Çıkış	HP	kW	IEC	V	A	d/d		Hm (mSS)	75	100	125	150	175	200
	Inlet x Outlet														
CES100-26 05504	5"x4"	7,5	5,5	112M	380/660	14,1	1500	Hm (mSS)		15	14	12			
CES100-26 07504		10	7,5	132M		15,7			17,5	17	16	14			
CES100-26 11004		15	11	132M		21,6			21,5	21	20,5	19,5	18		
CES100-26 15004		20	15	160L		29,8			25	24,5	24	23	22	20	

TİP TYPE	Bağlantı	MOTOR						m ³ /h	Debi (Q) - Capacity						
	Giriş x Çıkış	HP	kW	IEC	V	A	d/d		Hm (mSS)	100	125	150	175	200	220
	Inlet x Outlet														
CES100-32 11004	5"x4"	15	11	132M	380/660	21,6	1500	Hm (mSS)		23	21	18	16		
CES100-32 15004		20	15	160L		29,8			26	25	24	22	17		
CES100-32 18504		25	18,5	160L		35,8			32	29	28	26	24	23	
CES100-32 22004		30	22	160L		42,1			35	33	32	30	27	26	
CES100-32 30004		40	30	200L		57,3			36	35	33	32	29	27	

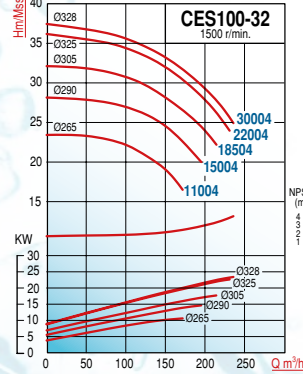
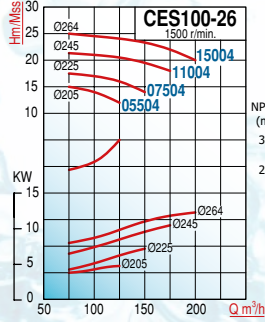
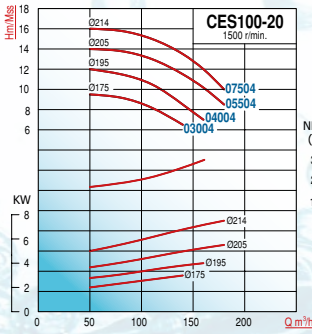

TİP TYPE	Boyutlar - Dimensions (mm)							
	A	h1	h2	H	E	n1	n2	L
CES100-20 03004	125	200	280	480	385	360	280	574
CES100-20 04004	125	200	280	480	385	360	280	618
CES100-20 05504	125	200	280	480	385	360	280	618
CES100-26 05504	140	225	280	505	420	400	315	660
CES100-26 07504	140	225	280	505	420	400	315	715
CES100-26 11004	140	225	280	505	420	400	315	742
CES100-26 15004	140	225	280	505	420	400	315	846
CES100-32 11004	140	250	315	565	485	400	315	728
CES100-32 15004	140	250	315	565	485	400	315	831
CES100-32 18504	140	250	315	565	485	400	315	884
CES100-32 22004	140	250	315	565	485	400	315	884
CES100-32 30004	140	250	315	565	485	400	315	920

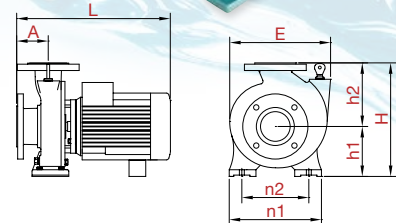

CES-i SERİSİ (3000 d/d & 1500 d/d) HAT TIPI (INLINE) SANTRİFÜJ POMPALAR

INLINE CENTRIFUGAL PUMPS



TEKNİK ÖZELLİKLER

- Motor: IE3 Sınıfı (Yüksek Verimli, Enerji Tasarruflı)
- Kapasite: 10 - 150 m³/h
- Basma Yüksekliği: 5 - 46 m
- Devir Hızı: 3000 d/d ve 1500 d/d
- Sıvı Sıcaklığı: -10 °C ~ +105 °C
- Flanslar TS EN 1092 - 2 / PN 16' ya uygundur.
- Giriş Flansları: DN50 - DN100
- Çıkış Flansları: DN50 - DN100
- İzolasyon sınıfı: F
- Koruma sınıfı: IP55
- Pompa Mili IEC ölçülerine uygun Genel maksat tip motorlara geçme şeklinde akuplaj yapılmıştır. Bu şekil akuplaj Pompa ve Motor milinin aynı hızda olmasını sağlar. Böylece çarkın dinamik ve statik olarak dengede çalışması sağlanır.
- Yataklama: Pompa Mili, Araparça (3000 d/d)denge rulmanı ve motor rulmanları tarafından yataklanır.
- Eksenel yük dengeleme delikleri ile dengelenir.

MALZEME ÖZELLİKLERİ

- Çark: PİK GG-25 PİK Döküm
- Gövde: GG-25 PİK Döküm
- Mil: X20Cr13 (AISI420) Opsiyonel: AISI316 çelik
- Sızdırmazlık: Mekanik salmastra (Karbon-Silisyum/Viton)
- Aşınma Halkası: GG-25 PİK Döküm

KULLANIM ALANLARI

- Soğutma & Isıtma sistemleri
- Sirkülasyon
- Buhar kazanları besli, kondens sistemleri
- Endüstriyel tesisler
- Hidrofor sistemleri
- Yangın söndürme sistemleri

OPSİYONEL

- Açık Çark
- Bronz Çark
- AISI 316 / AISI 304 Çelik Mil

TECHNICAL DATA

- Motor: IE3 Class (High Efficiency, Energy Saving)
- Capacity: 10 - 150 m³/h
- Total Head: 5 - 46
- Rotation Speed: 3000 rpm and 1500 rpm
- Liquid Temp.: -10°C ~ +105°C
- Suction and discharge flanges conform to EN 1092-2 / PN 16
- Inlet Flanges: DN50 - DN100
- Outlet Flanges: DN50 - DN100
- Insulation Class: F
- Protection Class: IP55
- CES series are designed to be driven by IEC standard motor. Pump shaft and motor shaft are close-coupled design. This way of coupling ensures the alignment of pump and motor. Therefore impeller runs in good balance both dynamically and statically.
- Bearing: Pump Shaft is supported by the ball bearing on pump support also by the ball bearings on electric motor (3000 d/d)
- Axial load is reduced by balance holes

MATERIAL SPECIFICATIONS

- Impellers: Cast iron GG-25
- Body: Cast iron GG-25
- Pump Shaft: X20Cr13 (AISI420) steel, Optional: AISI316 stainless steel.
- Non-Leakage: Mechanical seal (Carbon/Sic/Viton)
- Wear Ring: Cast iron GG-25

APPLICATIONS

- Chiller & Heating systems
- Circulation
- Boiler feeding, condens systems
- Industry
- Booster systems
- Fire fighting systems

OPTIONAL

- Open Impeller
- Bronze Impeller
- AISI 316 / AISI 304 S/S Shaft

CES-i40 (3000 d/d)

HAT TIPI (INLINE) SANTRİFÜJ POMPALAR

INLINE CENTRIFUGAL PUMPS

TİP TYPE	Bağlantı		MOTOR				m ³ /h Hm (mss)	Debi (Q) - Capacity						
	Giriş x Çıkış		HP	kW	V	A		d/d	1	10	12	15	20	25
	Inlet x Outlet													
CES-i40-13 01102	1,5" x 1,5"		1,5	1,1	380/660	2,4	3000	Hm (mss)	18	15	13,5	10,5		
CES-i40-13 01502			2	1,5		3,3			21	19	17,5	15	9,5	
CES-i40-13 02202			3	2,2		4,3			27	25,5	25	23	18	12,5
CES-i40-13 03002			4	3		6,3			30	29	28	26,5	22,5	17

TİP TYPE	Bağlantı		MOTOR				m ³ /h Hm (mss)	Debi (Q) - Capacity						
	Giriş x Çıkış		HP	kW	V	A		d/d	10	12	14	18	20	22
	Inlet x Outlet													
CES-i40-16 03002	1,5" x 1,5"		4	3	380/660	6,3	3000	Hm (mss)	32	31	28	22		
CES-i40-16 04002			5,5	4		7,75			40	39	37	33	30	26
CES-i40-16 05502			7,5	5,5		10,35			48	47	46	42	40	37

TİP TYPE	Bağlantı		MOTOR				m ³ /h Hm (mss)	Debi (Q) - Capacity						
	Giriş x Çıkış		HP	kW	V	A		d/d	10	20	25	30	35	40
	Inlet x Outlet													
CES-i40-20 04002	1,5" x 1,5"		5,5	4	380/660	7,75	3000	Hm (mss)	38	31	22			
CES-i40-20 05502			7,5	5,5		10,35			48	43	38	31		
CES-i40-20 07502			10	7,5		13,65			56	52	48	43	34	
CES-i40-20 11002			15	11		19,7			62	59	55	52	46	36

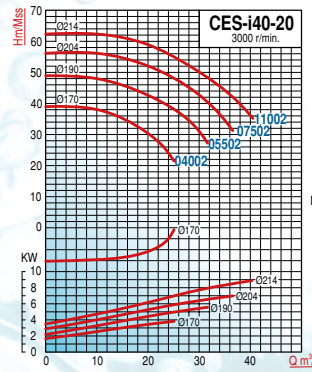
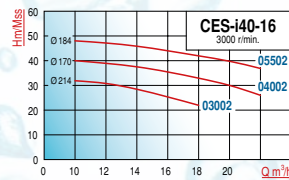
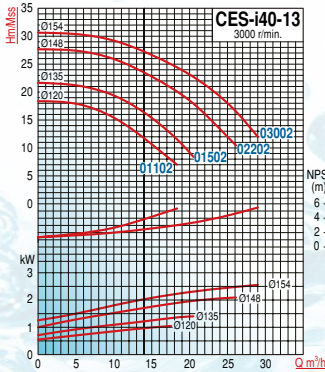

TİP TYPE	Boyutlar - Dimensions (mm)								Çark Çapı mm
	A	DN	h1	h2	H	E	g1	g2	
CES-i40-13 01102	75	40	160	140	300	208	108	100	120
CES-i40-13 01502	75	40	160	140	300	208	108	100	130
CES-i40-13 02202	75	40	160	140	300	208	108	100	147
CES-i40-13 03002	75	40	160	140	300	208	108	100	154
CES-i40-16 03002	75	40	180	160	340	232	122	110	155
CES-i40-16 04002	75	40	180	160	340	232	122	110	170
CES-i40-16 05502	75	40	180	160	340	232	122	110	214
CES-i40-20 04002	75	40	200	180	380	275	140	135	170
CES-i40-20 05502	75	40	200	180	380	275	140	135	190
CES-i40-20 07502	75	40	200	180	380	275	140	135	204
CES-i40-20 11002	75	40	200	180	380	275	140	135	214

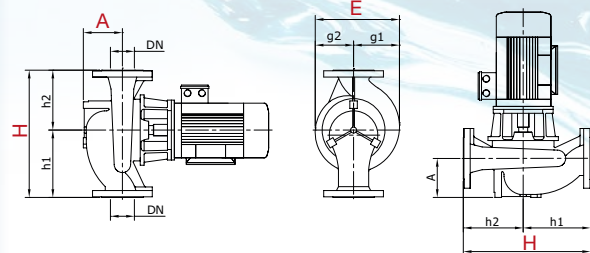

CES-i50 (3000 d/d) HAT TIPI (INLINE) SANTRİFÜJ POMPALAR

INLINE CENTRIFUGAL PUMPS

TİP TYPE	Bağlantı Giriş x Çıkış Inlet x Outlet	MOTOR					m ³ /h	Debi (Q) - Capacity					
		HP	kW	V	A	d/d		10	15	20	25	30	40
CES-i50-13 01502	2" x 2"	2	1,5	380/660	3,3	3000	Hm (mSS)	18	16	14	10		
CES-i50-13 02202		3	2,2		4,3			23	22	20	17	14	
CES-i50-13 03002		4	3		6,3			27	26	24	22	20	
CES-i50-13 04002		5,5	4		8			30	29	28	27	25	19
CES-i50-13 05502		7,5	5,5		10,9			33	32	31	30	28	23
CES-i50-16 03002	2" x 2"	4	3	380/660	6,3	3000	Hm (mSS)	26	24	20	5		
CES-i50-16 04002		5,5	4		8			33	32	30	20		
CES-i50-16 05502		7,5	5,5		10,9			40	39	38	34	19	
CES-i50-16 07502		10	7,5		14,1			48	47	45	42	36	16
CES-i50-16 11002		15	11		19,6			52	51	50	47	40	24
CES-i50-20 04002	2" x 2"	5,5	4	380/660	8	3000	Hm (mSS)	15	25	35	40	45	50
CES-i50-20 05502		7,5	5,5		10,9			37	20	5			
CES-i50-20 07502		10	7,5		14,1			44	35	20	15		
CES-i50-20 11002		15	11		19,6			49	46	40	34	24	
CES-i50-20 15002		20	15		28			58	57	53	50	45	38
CES-i50-26 11002	2" x 2"	15	11	380/660	19,6	3000	Hm (mSS)	10	20	30	40	50	60
CES-i50-26 15002		20	15		28			59	57	53	45		
CES-i50-26 18502		25	18,5		34			70	68	63	57	49	
CES-i50-26 22002		30	22		40,5			78	76	71	65	59	51
CES-i50-26 30002		40	30		54,6			90	88	83	76	69	60
								98	97	93	87	80	71

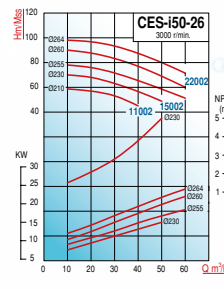
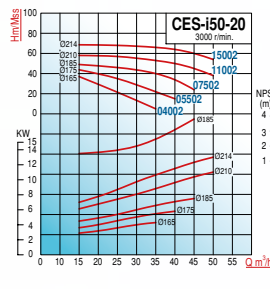
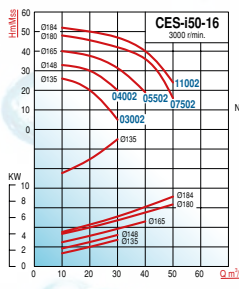
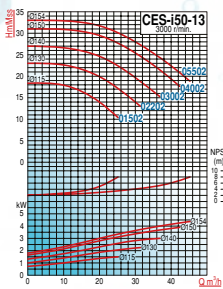

TİP TYPE	Boyutlar - Dimensions (mm)										Çark Çapı mm
	A	DN	h1	h2	H	E	g1	g2			
CES-i50-13 01502	90	50	160	140	300	212	110	112			116
CES-i50-13 02202	90	50	160	140	300	212	110	112			130
CES-i50-13 03002	90	50	160	140	300	212	110	112			140
CES-i50-13 04002	90	50	160	140	300	212	110	112			150
CES-i50-13 05502	90	50	160	140	300	212	110	112			154
CES-i50-16 03002	90	50	180	160	340	240	125	115			135
CES-i50-16 04002	90	50	180	160	340	240	125	115			148
CES-i50-16 05502	90	50	180	160	340	240	125	115			165
CES-i50-16 07502	90	50	180	160	340	240	125	115			180
CES-i50-16 11002	90	50	180	160	340	240	125	115			184
CES-i50-20 04002	90	50	225	200	425	282	145	137			165
CES-i50-20 05502	90	50	225	200	425	282	145	137			175
CES-i50-20 07502	90	50	225	200	425	282	145	137			185
CES-i50-20 11002	90	50	225	200	425	282	145	137			210
CES-i50-20 15002	90	50	225	200	425	282	145	137			214
CES-i50-26 11002	90	50	250	225	475	345	175	170			210
CES-i50-26 15002	90	50	250	225	475	345	175	170			230
CES-i50-26 18502	90	50	250	225	475	345	175	170			255
CES-i50-26 22002	90	50	250	225	475	345	175	170			260
CES-i50-26 30002	90	50	250	225	475	345	175	170			264

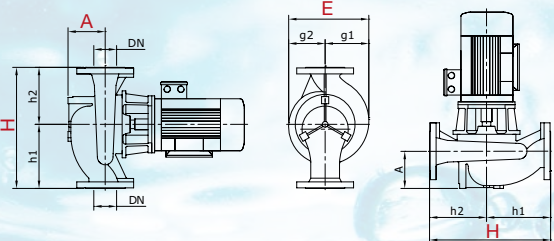

CES-i65 (3000 d/d) HAT TIPI (INLINE) SANTRİFÜJ POMPALAR

INLINE CENTRIFUGAL PUMPS

TİP TYPE	Bağlantı		MOTOR				m ³ /h	Debi (Q) - Capacity							
	Giriş x Çıkış		HP	kW	V	A		d/d	Hm (mSS)	25	35	40	50	60	65
	Inlet x Outlet														
CES-i65-13 03002	2.5" x 2.5"		4	3	380/660	6,3	3000	Hm (mSS)	19	16	14	8			
CES-i65-13 04002			5,5	4		7,75			24	22	20	15			
CES-i65-13 05502			7,5	5,5		10,3			28	26	25	21	14	11	
CES-i65-13 07502			10	7,5		13,6			31	30	28	25	19	16	
TİP TYPE	Bağlantı		MOTOR				m ³ /h	Debi (Q) - Capacity							
	Giriş x Çıkış		HP	kW	V	A		d/d	Hm (mSS)	20	30	40	50	60	70
	Inlet x Outlet														
CES-i65-16 05502	2.5" x 2.5"		7,5	5,5	380/660	10,3	3000	Hm (mSS)	34	32	28	22			
CES-i65-16 07502			10	7,5		13,6			41	40	38	34	26		
CES-i65-16 11002			15	11		19,6			50	49	48	46	41	35	
TİP TYPE	Bağlantı		MOTOR				m ³ /h	Debi (Q) - Capacity							
	Giriş x Çıkış		HP	kW	V	A		d/d	Hm (mSS)	30	40	50	60	70	80
	Inlet x Outlet														
CES-i65-20 11002	2.5" x 2.5"		15	11	380/660	19,6	3000	Hm (mSS)	45	43	41	38	34		
CES-i65-20 15002			20	15		28			54	52	49	46	42	38	
CES-i65-20 18502			25	18,5		34			59	58	55	52	48	42	
CES-i65-20 22002			30	22		40,5			64	63	61	58	54	48	
TİP TYPE	Bağlantı		MOTOR				m ³ /h	Debi (Q) - Capacity							
	Giriş x Çıkış		HP	kW	V	A		d/d	Hm (mSS)	30	40	55	70	85	105
	Inlet x Outlet														
CES-i65-26 18502	2.5" x 2.5"		25	18,5	380/660	34	3000	Hm (mSS)	67	65	60	54	45		
CES-i65-26 22002			30	22		40,5			75	73	68	62	53		
CES-i65-26 30002			40	30		54,6			93	91	86	79	70	55	
CES-i65-26 37002			50	37		68			101	99	94	87	79	64	

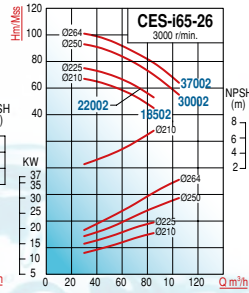
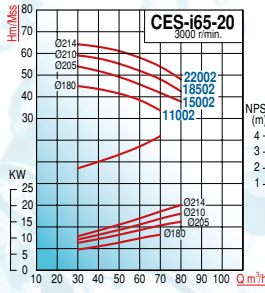
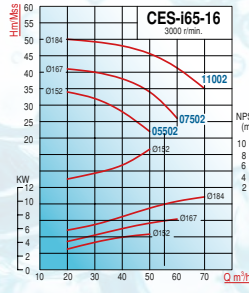
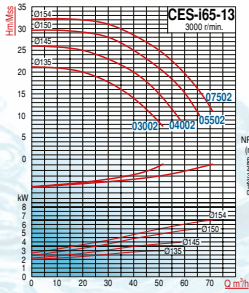

TİP TYPE	Boyutlar - Dimensions (mm)								Çark Çapı mm
	A	DN	h1	h2	H	E	g1	g2	
CES-i65-13 03002	110	40	180	160	340	229	122	107	132
CES-i65-13 04002	110	40	180	160	340	229	122	107	142
CES-i65-13 05502	110	40	180	160	340	229	122	107	148
CES-i65-13 07502	110	40	180	160	340	229	122	107	154
CES-i65-16 05502	110	65	200	180	380	255	135	120	152
CES-i65-16 07502	110	65	200	180	380	255	135	120	167
CES-i65-16 11002	110	65	200	180	380	255	135	120	184
CES-i65-20 11002	110	65	250	225	475	315	165	155	180
CES-i65-20 15002	110	65	250	225	475	315	165	155	205
CES-i65-20 18502	110	65	250	225	475	315	165	155	210
CES-i65-20 22002	110	65	250	225	475	315	165	155	214
CES-i65-26 18502	110	65	250	225	475	343	177	166	180
CES-i65-26 22002	110	65	250	225	475	343	177	166	205
CES-i65-26 30002	110	65	250	225	475	343	177	166	210
CES-i65-26 37002	110	65	250	225	475	343	177	166	214

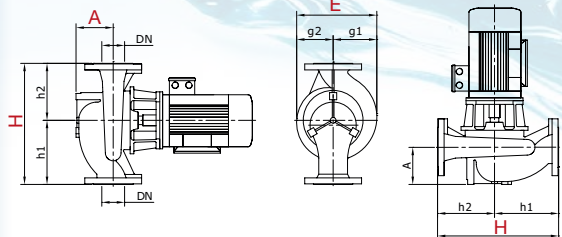

CES-i80 (3000 d/d) HAT TIPI (INLINE) SANTRİFÜJ POMPALAR

INLINE CENTRIFUGAL PUMPS

TİP TYPE	Bağlantı Giriş x Çıkış Inlet x Outlet	MOTOR						m ³ /h	Debi (Q) - Capacity					
		HP	kW	IEC	V	A	d/d		20	40	50	60	80	90
		CES-i80-13 04002	3" x 3"	5,5	4		380/660		7,75	3000	Hm (mSS)	21	19	16
CES-i80-13 05502	7,5	5,5			10,3	24		23	21			19	10	
CES-i80-13 07502	10	7,5			14,1	29		28	27			26	20	15
CES-i80-13 11002	15	11			19,6	32		31	30			29	25	20
TİP TYPE	Bağlantı Giriş x Çıkış Inlet x Outlet	MOTOR						m ³ /h	Debi (Q) - Capacity					
		HP	kW	IEC	V	A	d/d		20	40	60	80	100	120
		CES-i80-16 07502	3" x 3"	10	7,5	132M	380/660		14,1	3000	Hm (mSS)	28	26	23
CES-i80-16 11002	15	11		132M	19,6	35		34	32			25		
CES-i80-16 15002	20	15		160L	28	43		42	40			36	28	
CES-i80-16 18502	25	18,5		160L	34	47		46	45			42	36	26
TİP TYPE	Bağlantı Giriş x Çıkış Inlet x Outlet	MOTOR						m ³ /h	Debi (Q) - Capacity					
		HP	kW	IEC	V	A	d/d		80	100	125	140	150	155
		CES-i80-20 15002	3" x 3"	20	15	160L	380/660		28	3000	Hm (mSS)	33	31	27
CES-i80-20 18502	25	18,5		160L	34	44		40	34			28	22	15
CES-i80-20 22002	30	22		160L	40,5	48		44	38			32	26	17
CES-i80-20 30002	40	30		200L	54,6	57		53	48			43	36	25
TİP TYPE	Bağlantı Giriş x Çıkış Inlet x Outlet	MOTOR						m ³ /h	Debi (Q) - Capacity					
		HP	kW	IEC	V	A	d/d		30	50	125	150	155	160
		CES-i80-26 22002	3" x 3"	30	22	160L	380/660		40,5	3000	Hm (mSS)	59	58	43
CES-i80-26 30002	40	30		200L	54,6	65		64	52			39	32	12
CES-i80-26 37002	50	37		200L	68	81		80	67			55	50	40
CES-i80-26 45002	60	45		200L	83,8	91		90	88			72	66	60

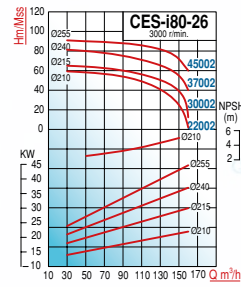
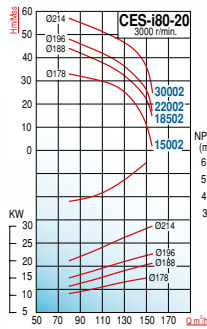
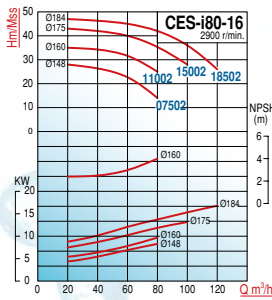
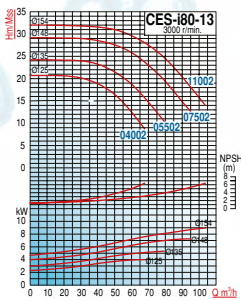

TİP TYPE	Boyutlar - Dimensions (mm)								Çark Çapı mm
	A	DN	h1	h2	H	E	g1	g2	
CES-i80-13 04002	110	80	200	180	380	252	138	114	125
CES-i80-13 05502	110	80	200	180	380	252	138	114	135
CES-i80-13 07502	110	80	200	180	380	252	138	114	148
CES-i80-13 11002	110	80	200	180	380	252	138	114	154
CES-i80-16 07502	130	80	225	200	425	281	153	128	148
CES-i80-16 11002	130	80	225	200	425	281	153	128	160
CES-i80-16 15002	130	80	225	200	425	281	153	128	175
CES-i80-16 18502	130	80	225	200	425	281	153	128	184
CES-i80-20 15002	130	80	250	225	475	315	170	145	175
CES-i80-20 18502	130	80	250	225	475	315	170	145	195
CES-i80-20 22002	130	80	250	225	475	315	170	145	205
CES-i80-20 30002	130	80	250	225	475	315	170	145	214
CES-i80-26 22002	140	80	280	280	560	379	197	182	210
CES-i80-26 30002	140	80	280	280	560	379	197	182	215
CES-i80-26 37002	140	80	280	280	560	379	197	182	240
CES-i80-26 45002	140	80	280	280	560	379	197	182	255

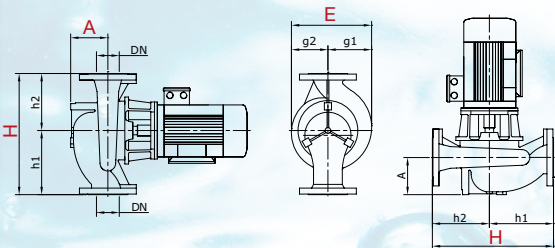

CES-i100 (3000 d/d) HAT TIPI (INLINE) SANTRİFÜJ POMPALAR

INLINE CENTRIFUGAL PUMPS

TİP TYPE	Bağlantı Giriş x Çıkış Inlet x Outlet	MOTOR						m ³ /h	Debi (Q) - Capacity					
		HP	kW	IEC	V	A	d/d		70	100	130	160	190	220
		CES-i100-16 11002	4" x 4"	15	11	132	380/660		19,6	3000	Hm (mSS)	26	25	23
CES-i100-16 15002	20	15		160	26,7	30		29	27,5			25	20	13
CES-i100-16 18502	25	18,5		160	32,6	34		33	31,5			29	25	18
CES-i100-16 22002	30	22		160	31,4	38		37	35,5			33	29	23

TİP TYPE	Bağlantı Giriş x Çıkış Inlet x Outlet	MOTOR						m ³ /h	Debi (Q) - Capacity					
		HP	kW	IEC	V	A	d/d		90	120	150	180	210	240
		CES-i100-20 18502	4" x 4"	25	18,5	160L	380/660		32,6	3000	Hm (mSS)	41	39	35
CES-i100-20 22002	30	22		160L	40,5	47		46	44			40	33	
CES-i100-20 30002	40	30		200L	54,6	53		52	50			46	40	32
CES-i100-20 37002	50	37		200L	68	58		57	55			52	47	40
CES-i100-20 45002	60	45		200L	83,8	64		63	62			59	54	46

TİP TYPE	Bağlantı Giriş x Çıkış Inlet x Outlet	MOTOR						m ³ /h	Debi (Q) - Capacity					
		HP	kW	IEC	V	A	d/d		70	100	130	160	190	220
		CES-i100-26 30002	4" x 4"	40	30	200L	380/660		56,6	3000	Hm (mSS)	59	58	55
CES-i100-26 37002	50	37		200L	68	64		63	61			57	49	35
CES-i100-26 45002	60	45		200L	83,8	70		69	67			63	57	48

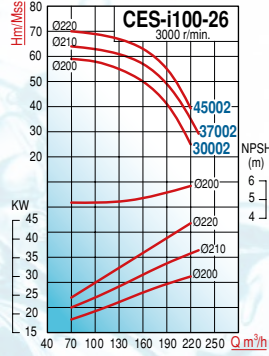
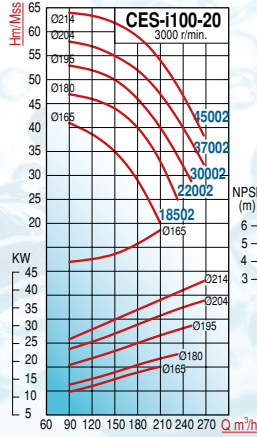
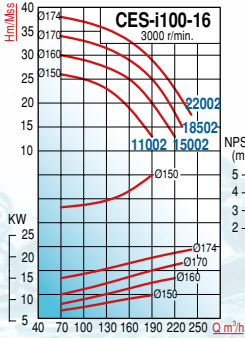

TİP TYPE	Boyutlar - Dimensions (mm)								Çark Çapı mm
	A	DN	h1	h2	H	E	g1	g2	
CES-i100-16 11002	130	100	250	225	475	292	162	130	150
CES-i100-16 15002	130	100	250	225	475	292	162	130	160
CES-i100-16 18502	130	100	250	225	475	292	162	130	170
CES-i100-16 22002	130	100	250	225	475	292	162	130	174
CES-i100-20 18502	170	100	275	250	525	365	170	195	165
CES-i100-20 22002	170	100	275	250	525	365	170	195	180
CES-i100-20 30002	170	100	275	250	525	365	170	195	185
CES-i100-20 37002	170	100	275	250	525	365	170	195	204
CES-i100-20 45002	170	100	275	250	525	365	170	195	214
CES-i100-26 30002	170	100	300	280	580	390	210	180	200
CES-i100-26 37002	170	100	300	280	580	390	210	180	210
CES-i100-26 45002	170	100	300	280	580	390	210	180	220

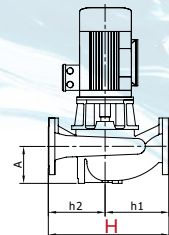
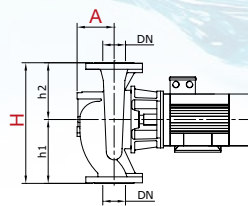

CES-i40 (1500 d/d) HAT TIPI (INLINE) SANTRİFÜJ POMPALAR

1500 d/d

INLINE CENTRIFUGAL PUMPS

TİP TYPE	Bağlantı Giriş x Çıkış Inlet x Outlet	MOTOR					m ³ /h Hm (mss)	Debi (Q) - Capacity					
		HP	kW	V	A	d/d		1	6	8	10	14	16
		CES-i40-13 00254	1,5" x 1,5"	0,33	0,25	380		0,95	1500	Hm (mss)	6	5,5	5
CES-i40-13 00374	0,5	0,37		1,45	7,5		7	6,5			6	3,5	2,5

TİP TYPE	Bağlantı Giriş x Çıkış Inlet x Outlet	MOTOR					m ³ /h Hm (mss)	Debi (Q) - Capacity					
		HP	kW	V	A	d/d		1	6	8	10	12	14
		CES-i40-16 00554	1,5" x 1,5"	0,75	0,55	380		1,45	1500	Hm (mss)	10,5	10,2	9,4
CES-i40-16 00754	1	0,75		1,95	11,6		11,2	10,7			9,7	8,8	8

TİP TYPE	Bağlantı Giriş x Çıkış Inlet x Outlet	MOTOR					m ³ /h Hm (mss)	Debi (Q) - Capacity					
		HP	kW	V	A	d/d		2	5	10	13	15	20
		CES-i40-20 00554	1,5" x 1,5"	0,75	0,55	380		1,45	1500	Hm (mss)	10	9,5	7,5
CES-i40-20 00754	1	0,75		1,95	12,5		12	10,5			9	7,5	
CES-i40-20 01104	1,5	1,1		2,64	15		14,5	13,5			12,5	11	7,5

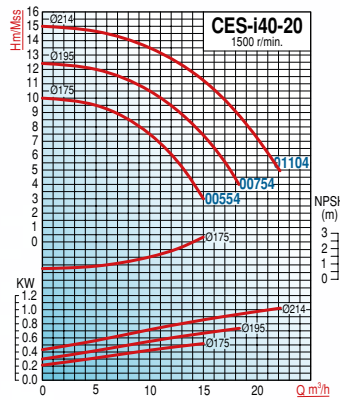
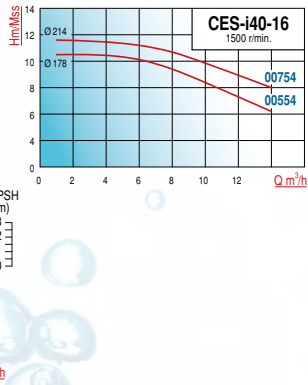
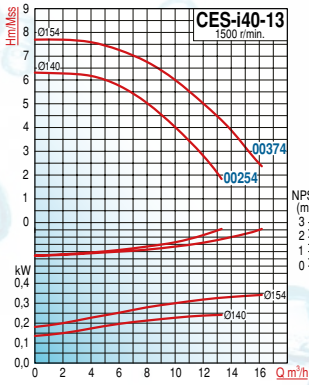

TİP TYPE	Boyutlar - Dimensions (mm)							Çark Çapı mm	
	A	DN	h1	h2	H	E	g1		g2
CES-i40-13 00374	75	40	160	140	300	208	108	100	140
CES-i40-13 00554	75	40	160	140	300	208	108	100	154
CES-i40-16 00554	75	40	180	160	340	293	122	110	178
CES-i40-16 00754	75	40	180	160	340	232	122	110	214
CES-i40-20 00554	75	40	200	180	380	275	140	135	175
CES-i40-20 00754	75	40	200	180	380	275	140	135	195
CES-i40-20 01104	75	40	200	180	380	275	140	135	214

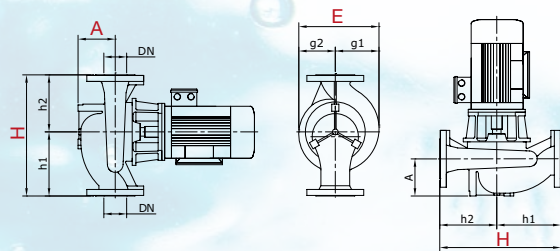

CES-i65 (1500 d/d) HAT TIPI (INLINE) SANTRİFÜJ POMPALAR

1500 d/d

INLINE CENTRIFUGAL PUMPS

TİP TYPE	Bağlantı Giriş x Çıkış Inlet x Outlet	MOTOR					m ³ /h Hm (mSS)	Debi (Q) - Capacity					
		HP	kW	V	A	d/d		0	10	12	16	20	25
								0	10	12	16	20	25
CES-i65-13 00374	2.5" x 2.5"	0,5	0,37	380	0,95	1500	Hm (mSS)	4,5	4,4	4,2	3,6	3	
CES-i65-13 00554		0,75	0,55		1,45			6,5	6,4	6,3	6	5,5	
CES-i65-13 00754		1	0,75		1,95			7,5	7,4	7,3	7,2	6,6	5,5
TİP TYPE	Bağlantı Giriş x Çıkış Inlet x Outlet	MOTOR					m ³ /h Hm (mSS)	Debi (Q) - Capacity					
		HP	kW	V	A	d/d		10	15	20	25	30	35
								10	15	20	25	30	35
CES-i65-16 00754	2.5" x 2.5"	1	0,75	380	1,95	1500	Hm (mSS)	8,5	8	7	5,5		
CES-i65-16 01104		1,5	1,1		2,6			10,5	10	9,5	8,5	7	
CES-i65-16 01504		2	1,5		3,4			12,5	12	11,5	11	10	8,5
TİP TYPE	Bağlantı Giriş x Çıkış Inlet x Outlet	MOTOR					m ³ /h Hm (mSS)	Debi (Q) - Capacity					
		HP	kW	V	A	d/d		15	20	25	30	35	40
								15	20	25	30	35	40
CES-i65-20 01104	2.5" x 2.5"	1,5	1,1	380	2,6	1500	Hm (mSS)	10,5	10	9	8		
CES-i65-20 01504		2	1,5		3,5			12,5	12,2	11,5	10,5	9,5	
CES-i65-20 02204		3	2,2		5,1			15	14,5	14	13,5	12,5	11
CES-i65-20 03004		4	3		2,6			16,5	16	15,5	15	14	12,5
TİP TYPE	Bağlantı Giriş x Çıkış Inlet x Outlet	MOTOR					m ³ /h Hm (mSS)	Debi (Q) - Capacity					
		HP	kW	V	A	d/d		15	25	30	35	40	50
								15	25	30	35	40	50
CES-i65-26 02204	2.5" x 2.5"	3	2,2	380	4,8	1500	Hm (mSS)	15,5	14,5	13	11		
CES-i65-26 03004		4	3		6,6			19,5	19	18	16,5	14,5	
CES-i65-26 04004		5,5	4		8,3			22,5	22	21,5	21	20	17
CES-i65-26 05504		7,5	5,5		14,1			24,5	24	23,5	23	22	19

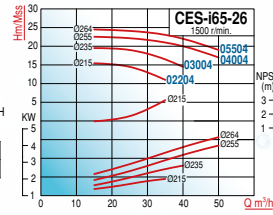
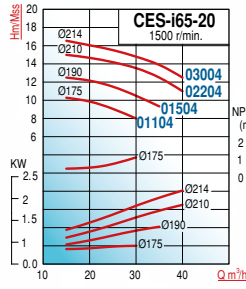
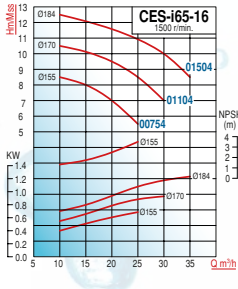
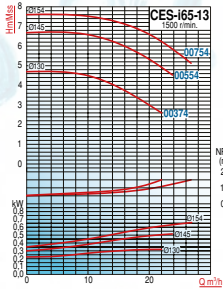

TİP TYPE	Boyutlar - Dimensions (mm)								Çark Çapı mm
	A	DN	h1	h2	H	E	g1	g2	
CES-i65-13 00374	110	40	180	160	340	229	122	107	130
CES-i65-13 00554	110	40	180	160	340	229	122	107	145
CES-i65-13 00754	110	40	180	160	340	229	122	107	154
CES-i65-16 00754	110	65	200	180	380	255	135	120	155
CES-i65-16 01104	110	65	200	180	380	255	135	120	170
CES-i65-16 01504	110	65	200	180	380	255	135	120	184
CES-i65-20 01104	110	65	250	225	475	315	165	155	175
CES-i65-20 01504	110	65	250	225	475	315	165	155	190
CES-i65-20 02204	110	65	250	225	475	315	165	155	210
CES-i65-20 03004	110	65	250	225	475	315	165	155	214
CES-i65-26 02204	110	65	250	225	475	343	177	166	175
CES-i65-26 03004	110	65	250	225	475	343	177	166	190
CES-i65-26 04004	110	65	250	225	475	343	177	166	210
CES-i65-26 05504	110	65	250	225	475	343	177	166	214

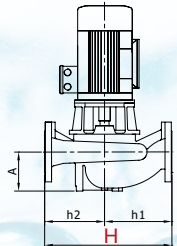
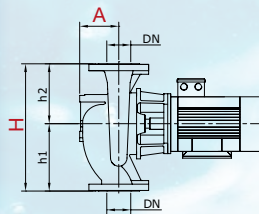

CES-i80 (1500 d/d)

HAT TIPI (INLINE) SANTRİFÜJ POMPALAR

1500 d/d

INLINE CENTRIFUGAL PUMPS

TİP TYPE	Bağlantı Giriş x Çıkış Inlet x Outlet	MOTOR						m ³ /h	Debi (Q) - Capacity					
		HP	kW	IEC	V	A	d/d		10	15	20	25	35	45
									Hm (mSS)					
CES-i80-13 00374	3" x 3"	0,50	0,37	71M	380/660	0,8	1500	Hm (mSS)	4	3,8	3,2	2,2		
CES-i80-13 00554		1	0,55	80M		1,45			5,2	5	4,8	4,2	2,2	
CES-i80-13 00754		1	0,75	80M		1,95			6,4	6,3	6,2	5,8	4,4	
CES-i80-13 01104		2	1,1	80M		2,6			7,4	7,3	7,2	7	6	4
TİP TYPE	Bağlantı Giriş x Çıkış Inlet x Outlet	MOTOR						m ³ /h	Debi (Q) - Capacity					
HP	kW	IEC	V	A	d/d	10	20		30	40	50	60		
						Hm (mSS)								
CES-i80-16 00554	3" x 3"	0,75	0,55	80M	380/660	1,45	1500	Hm (mSS)	5	4	3			
CES-i80-16 00754		1	0,75	80M		1,95			7	6	5	3		
CES-i80-16 01104		1,5	1,1	80M		2,6			9	8	7	5		
CES-i80-16 01504		2	1,5	90L		3,5			10	9	8	7	6	
CES-i80-16 02204		3	2,2	90L		5,1			12	11	10	9	8	6
TİP TYPE	Bağlantı Giriş x Çıkış Inlet x Outlet	MOTOR						m ³ /h	Debi (Q) - Capacity					
HP	kW	IEC	V	A	d/d	15	30		45	60	75	90		
						Hm (mSS)								
CES-i80-20 01504	3" x 3"	2	1,5	90L	380/660	1,45	1500	Hm (mSS)	9	8,5	7	5		
CES-i80-20 02204		3	2,2	90L		1,95			11	10,5	9,5	7,5		
CES-i80-20 03004		4	3	100L		2,6			14	13,5	12,5	11	8,5	
CES-i80-20 04004		5,5	4	100L		3,5			16	15,5	14,5	13	11	8
TİP TYPE	Bağlantı Giriş x Çıkış Inlet x Outlet	MOTOR						m ³ /h	Debi (Q) - Capacity					
HP	kW	IEC	V	A	d/d	20	35		45	55	65	75		
						Hm (mSS)								
CES-i80-26 02204	3" x 3"	3	2,2	90L	380/660	5,1	1500	Hm (mSS)	13,5	12	9	2		
CES-i80-26 03004		4	3	100L		6,6			16	15,5	14,5	12,5		
CES-i80-26 04004		5,5	4	100L		8,3			19,5	19	17,5	16	14	
CES-i80-26 05504		7,5	5,5	112M		14,1			22,5	22	21	20	19	17,5
CES-i80-26 07504		10	7,5	132M		15,7			25	24,5	24	23	22	20

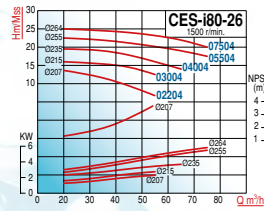
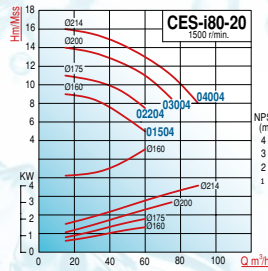
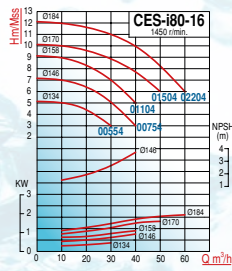
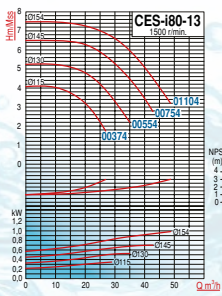

TİP TYPE	Boyutlar - Dimensions (mm)								Çark Çapı mm
	A	DN	h1	h2	H	E	g1	g2	
CES-i80-13 00374	110	80	200	180	380	252	138	114	115
CES-i80-13 00554	110	80	200	180	380	252	138	114	130
CES-i80-13 00754	110	80	200	180	380	252	138	114	145
CES-i80-13 01104	110	80	200	180	380	252	138	114	154
CES-i80-16 00554	130	80	225	200	425	281	153	128	134
CES-i80-16 00754	130	80	225	200	425	281	153	128	146
CES-i80-16 01104	130	80	225	200	425	281	153	128	158
CES-i80-16 01504	130	80	225	200	425	281	153	128	174
CES-i80-16 02204	130	80	225	200	425	281	153	128	184
CES-i80-20 01504	130	80	250	225	475	315	170	145	160
CES-i80-20 02204	130	80	250	225	475	315	170	145	175
CES-i80-20 03004	130	80	250	225	475	315	170	145	200
CES-i80-20 04004	130	80	250	225	475	315	170	145	214
CES-i80-26 03004	140	80	280	280	560	379	197	182	215
CES-i80-26 04004	140	80	280	280	560	379	197	182	235
CES-i80-26 05504	140	80	280	280	560	379	197	182	255
CES-i80-26 07504	140	80	280	280	560	379	197	182	264

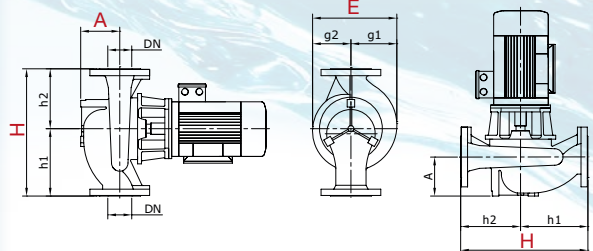

CES-i100 (1500 d/d) HAT TIPI (INLINE) SANTRİFÜJ POMPALAR

1500 d/d

INLINE CENTRIFUGAL PUMPS

TİP TYPE	Bağlantı Giriş x Çıkış Inlet x Outlet	MOTOR						m ³ /h	Debi (Q) - Capacity					
		HP	kW	IEC	V	A	d/d		30	40	50	60	70	80
		CES-i100-16 01504	4" x 4"	2	1,5	90	380/660		1,45	1500	Hm (mSS)	8,5	7,5	6,5
CES-i100-16 02204	3	2,2		90	1,95	10,5		10	9,5			8,5	7,5	6
CES-i100-16 03004	4,0	3		90	2,6	12		11,5	11			10	9	7,5

TİP TYPE	Bağlantı Giriş x Çıkış Inlet x Outlet	MOTOR						m ³ /h	Debi (Q) - Capacity					
		HP	kW	IEC	V	A	d/d		40	55	70	85	100	115
		CES-i100-20 03004	4" x 4"	4	3	100L	380/660		6,6	1500	Hm (mSS)	11	10	9,5
CES-i100-20 04004	5,5	4		100L	8,3	13		12,5	12			11	6,5	
CES-i100-20 05504	7,5	5,5		112M	11,4	15		14,5	14			13,5	10,5	8

TİP TYPE	Bağlantı Giriş x Çıkış Inlet x Outlet	MOTOR						m ³ /h	Debi (Q) - Capacity					
		HP	kW	IEC	V	A	d/d		40	60	80	100	115	130
		CES-i100-26 04004	4" x 4"	5,5	4	100L	380/660		8,3	1500	Hm (mSS)	15	14,5	13,5
CES-i100-26 05504	7,5	5,5		112M	14,1	17,5		17	16			15	13	
CES-i100-26 07504	10	7,5		132M	15,7	21,5		21	20			18,5	16,5	14
CES-i100-26 11004	15	11		132M	21,6	24,5		24	23,5			22	20,5	18,5

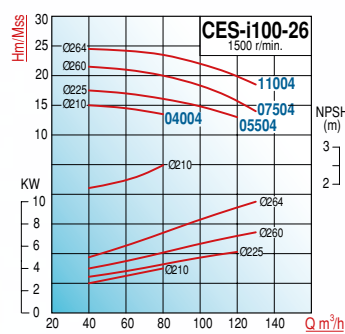
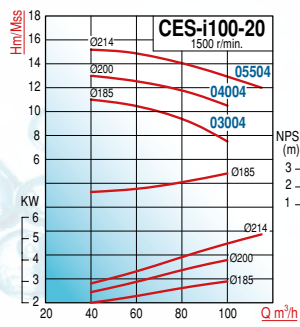
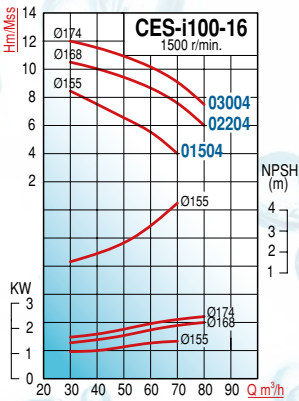

TİP TYPE	Boyutlar - Dimensions (mm)								Çark Çapı mm
	A	DN	h1	h2	H	E	g1	g2	
CES-i100-16 01504	130	100	250	225	475	292	162	130	155
CES-i100-16 02204	130	100	250	225	475	292	162	130	168
CES-i100-16 03004	130	100	250	225	475	292	162	130	174
CES-i100-20 03004	170	100	275	250	525	365	170	195	185
CES-i100-20 04004	170	100	275	250	525	365	170	195	200
CES-i100-20 05504	170	100	275	250	525	365	170	195	214
CES-i100-26 04004	170	100	300	280	580	390	210	180	210
CES-i100-26 05504	170	100	300	280	580	390	210	180	225
CES-i100-26 07504	170	100	300	280	580	390	210	180	245
CES-i100-26 11004	170	100	300	280	580	390	210	180	264

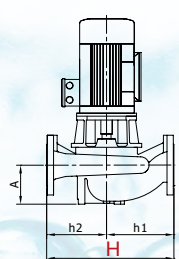
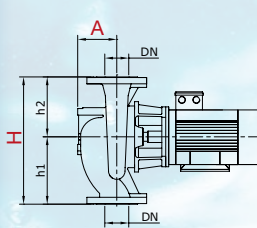

ES (3000 d/d & 1500 d/d) (TS EN 733)

SALYANGOZ KAPLINLI POMPALAR (Yumuşak veya Mekanik Salmastralı)

VOLUTE CASING LONG-COUPLED PUMPS (Soft Packing / Mechanical Seal)



TEKNİK ÖZELLİKLER

- Kapasite: 10 - 320 m³/h
- Basma Yüksekliği: 9 - 156 m
- Devir Hızı: 1500 - 3000 d/d
- Sıvı Sıcaklığı: -10 °C ~ +110 °C
- Flanşlar TS EN 1092 - 2 / PN 16' ya uygundur.
- Giriş Flanşları: DN65 - DN125
- Çıkış Flanşları: DN 40 - DN100 (Flanşlar opsiyoneldir.)
- Yataklama: Mil yatağındaki 2 adet ağır hizmet tipi rulmanla sağlanır/ Gres yağlamalı (opsiyonel)
- Eksenel yük çark dengeleme delikleri ile dengelenir
- İzolasyon sınıfı: F
- Koruma sınıfı: IP55
- Emme derinliği: 6.5mt.

MALZEME ÖZELLİKLERİ

- Çark: PİK GG-25
- Emici ve Verici Gövde: PİK GG-25
- Mil: X20Cr13 (AISI420), Opsiyonel: AISI316 çelik
- Sızdırmazlık: Yumuşak veya Mekanik salmastra (Ca-Sic-Viton)
- Kaplin: Elastik
- Aşınma Halkası: GG-25 PİK Döküm

KULLANIM ALANLARI

- Temiz su temini
- Tarımsal sulama(Damlama ve Sprink sistemleri)
- Buhar kazanları besli,
- Kondens sistemleri
- Endüstri ve İnşaatlar
- Soğutma sistemleri
- Sirkülasyon
- Yangın söndürme

OPSİYONEL

- Açık Çark
- Bronz Çark
- AISI 316 / AISI 304 Çelik Mil

TECHNICAL DATA

- Capacity: 10 - 320 m³/h
- Total Head: 9 - 156
- Rotation Speed: 1500 - 3000 rpm
- Liquid Temp.: -10°C ~ +110°C
- Suction and discharge flanges conform to EN 1092-2 / PN 16
- Inlet Flanges: DN65 - DN125
- Outlet Flanges: DN40 - DN100 (Flanges are optional)
- Bearing: Pump Shaft is supported by 2 Heavy duty ball bearings on bearing housing / Grease lubricated (Optional)
- Axial load is reduced by balance holes
- Insulation Class: F
- Protection Class: IP55
- Suction lift: Max 6.5 m.

MATERIAL SPECIFICATIONS

- Impellers: Cast iron GG-25
- Inlet & Outlet Bodies: Cast iron GG-25
- Pump Shaft: X20Cr13 (AISI420) steel, Optional: AISI316 stainless steel.
- Non-Leakage: Soft packing / Mechanical seal (Ca-Sic-Viton)
- Coupling: Flexible
- Wear Ring: Cast iron GG-25

APPLICATIONS

- Clean water supply
- Irrigation (Drip and Sprinkler systems)
- Boiler feeding
- Condens systems
- Industrial plants, Constructions
- Chiller systems
- Circulation
- Fire fighting

OPTIONAL

- Open Impeller
- Bronze Impeller
- AISI 316 / AISI 304 S/S Shaft

ES40 (3000 d/d) (Yumuşak veya Mekanik Salmastralı) SALYANGOZ KAPLINLI POMPALAR

VOLUTE CASING LONG-COUPLED PUMPS (Soft Packing / Mechanical Seal)

TİP TYPE	Bağlantı Giriş x Çıkış Inlet x Outlet	MOTOR			m ³ /h	Debi (Q) - Capacity					
		HP	kW	V		10	15	20	30	40	50
ES40-16 04002	2.5"x1.5"	5,5	4	380	Hm (mSS)	32	31	29	24		
ES40-16 05502		7,5	5,5	380 / 660		40	39	38	34	23	
ES40-16 07502		10	7,5			48	47	46	44	37	22
ES40-16 11002		15	11			53	52	51	49	44	34

TİP TYPE	Bağlantı Giriş x Çıkış Inlet x Outlet	MOTOR			m ³ /h	Debi (Q) - Capacity					
		HP	kW	V		15	25	30	35	40	50
ES40-20 04002	2.5" x 1.5"	5,5	4	380	Hm (mSS)	37	20	5			
ES40-20 05502		7,5	5,5	380 / 660		44	35	20	15		
ES40-20 07502		10	7,5			45	42	39	35	30	
ES40-20 11002		15	11			59	58	56	53	48	37
ES40-20 15002		20	15			66	65	63	60	56	45

TİP TYPE	Bağlantı Giriş x Çıkış Inlet x Outlet	MOTOR			m ³ /h	Debi (Q) - Capacity					
		HP	kW	V		10	20	30	40	50	60
ES40-26 15002	2.5" x 1.5"	20	15	380 / 660	Hm (mSS)	70	68	63	57	49	
ES40-26 18502		25	18.5			78	76	72	66	59	51
ES40-26 22002		30	22			90	88	83	77	69	60
ES40-26 30002		40	30			98	97	93	87	80	71

TİP TYPE	Bağlantı Giriş x Çıkış Inlet x Outlet	MOTOR			m ³ /h	Debi (Q) - Capacity					
		HP	kW	V		15	20	30	35	40	50
ES40-32 22002	2.5" x 1.5"	30	22	380 / 660	Hm (mSS)	93	92	89	86	82	
ES40-32 30002		40	30			105	103	99	97	94	
ES40-32 37002		50	37			130	129	124	121	118	110
ES40-32 45002		60	45			143	142	137	134	131	123
ES40-32 55002		75	55			156	155	151	148	145	140



ES40 (3000 d/d) (Yumuşak veya Mekanik Salmastralı) SALYANGOZ KAPLINLİ POMPALAR

VOLUTE CASING LONG-COUPLED PUMPS (Soft Packing / Mechanical Seal)

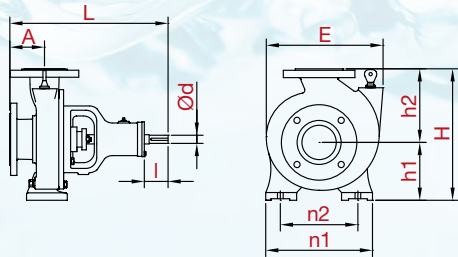
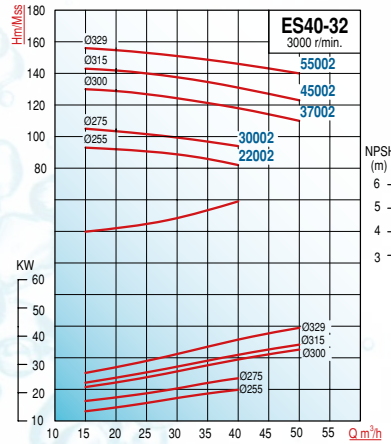
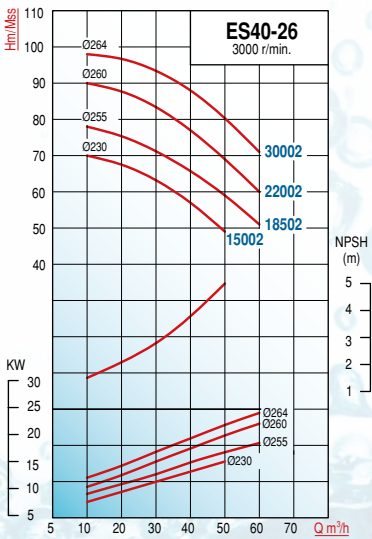
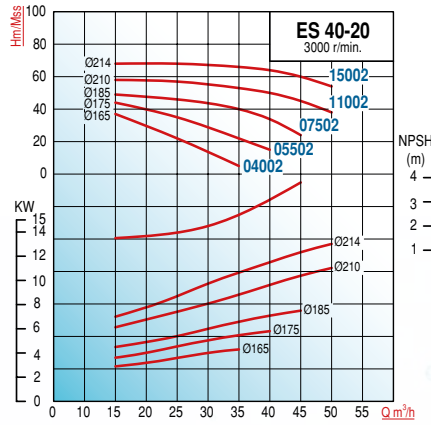
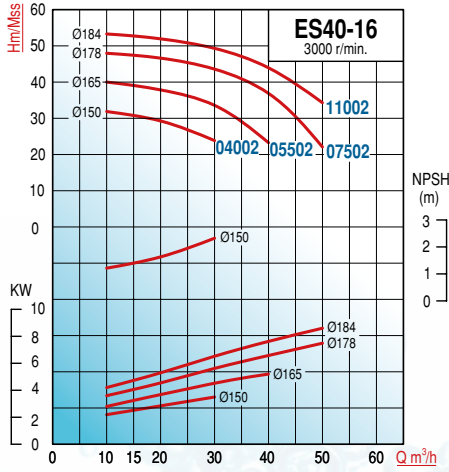

TİP TYPE	Boyutlar - Dimensions (mm)										Ağırlık - Weight
	A	L	h1	h2	H	E	n1	n2	l	d	Kg
ES40-16	80	445	132	160	292	246	240	190	55	24	35
ES40-20	100	460	160	180	340	290	265	212	55	24	42
ES40-26	100	460	180	225	405	340	320	250	55	24	59
ES40-32	125	595	200	250	450	400	345	280	80	32	87

ES50 (3000 d/d) (Yumuşak veya Mekanik Salmastralı) SALYANGOZ KAPLINLİ POMPALAR

VOLUTE CASING LONG-COUPLED PUMPS (Soft Packing / Mechanical Seal)

TİP TYPE	Bağlantı Giriş x Çıkış Inlet x Outlet	MOTOR			m ³ /h	Debi (Q) - Capacity					
		HP	kW	V		20	30	40	50	60	70
	ES50-16 05502	2.5" x 2"	7,5	5,5		380/660	Hm (mSS)	29	28	26	22
ES50-16 07502	10		7,5	37	36			34	31	26	
ES50-16 11002	15		11	47	46			45	42	39	35

TİP TYPE	Bağlantı Giriş x Çıkış Inlet x Outlet	MOTOR			m ³ /h	Debi (Q) - Capacity					
		HP	kW	V		30	40	50	60	70	80
	ES50-20 11002	2.5" x 2"	15	11		380/660	Hm (mSS)	45	43	41	38
ES50-20 15002	20		15	54	52			49	46	42	38
ES50-20 18502	25		18,5	59	58			55	52	48	42
ES50-20 22002	30		22	64	63			61	58	54	48

TİP TYPE	Bağlantı Giriş x Çıkış Inlet x Outlet	MOTOR			m ³ /h	Debi (Q) - Capacity					
		HP	kW	V		30	40	55	70	85	105
	ES50-26 18502	2.5" x 2"	25	18,5		380/660	Hm (mSS)	67	65	60	54
ES50-26 22002	30		22	75	73			68	62	53	
ES50-26 30002	40		30	93	91			86	79	70	55
ES50-26 37002	50		37	101	99			94	88	79	64

TİP TYPE	Bağlantı Giriş x Çıkış Inlet x Outlet	MOTOR			m ³ /h	Debi (Q) - Capacity					
		HP	kW	V		30	45	60	75	90	105
	ES50-32 30002	2.5" x 2"	40	30		380/660	Hm (mSS)	88	87	83	72
ES50-32 37002	50		37	99	98			95	87	68	
ES50-32 45002	60		45	112	111			107	99	84	52
ES50-32 55002	75		55	135	134			131	125	112	90
ES50-32 75002	100		75	147	146			144	138	128	112



ES50 (3000 d/d) (Yumuşak veya Mekanik Salmastralı) **SALYANGOZ KAPLINLİ POMPALAR**

VOLUTE CASING LONG-COUPLED PUMPS (Soft Packing / Mechanical Seal)

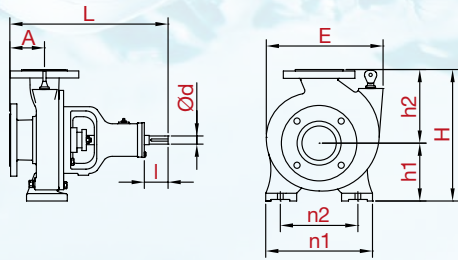
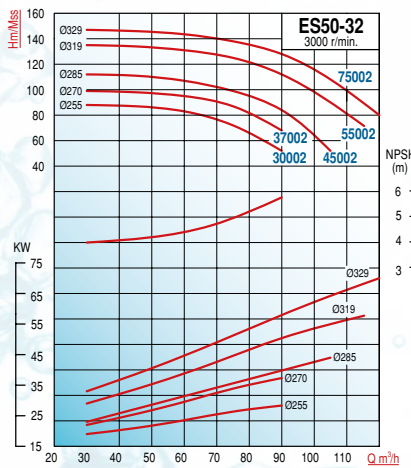
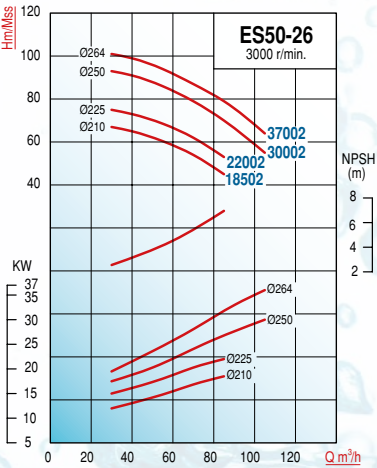
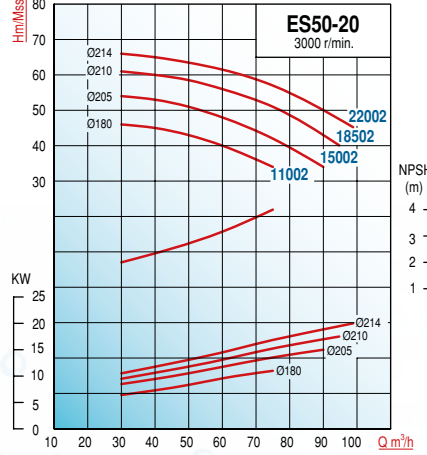
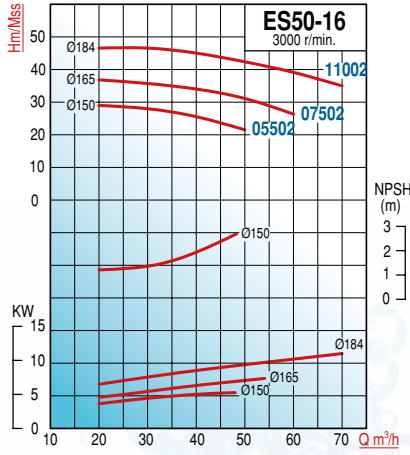

TİP TYPE	Boyutlar - Dimensions (mm)										Ağırlık - Weight Kg
	A	L	h1	h2	H	E	n1	n2	l	d	
ES50-16	100	465	160	180	340	271	265	212	55	24	40
ES50-20	100	460	160	200	360	305	265	212	55	24	47
ES50-26	100	460	180	225	405	335	320	250	55	24	62
ES50-32	125	595	225	280	507	417	345	280	80	32	90

ES65 (3000 d/d) (Yumuşak veya Mekanik Salmastralı)

SALYANGOZ KAPLINLI POMPALAR

VOLUTE CASING LONG-COUPLED PUMPS (Soft Packing / Mechanical Seal)

TİP TYPE	Bağlantı Giriş x Çıkış Inlet x Outlet	MOTOR			m ³ /h Hm (mss)	Debi (Q) - Capacity					
		HP	kW	V		30	60	90	110	125	140
	ES65-16 07502	3" x 2.5"	10	7,5		380/660	Hm (mss)	30	26	18	13
ES65-16 11002	15		11	36	33			26	22	17	5
ES65-16 15002	20		15	42	38			33	27	22	16

TİP TYPE	Bağlantı Giriş x Çıkış Inlet x Outlet	MOTOR			m ³ /h Hm (mss)	Debi (Q) - Capacity					
		HP	kW	V		80	100	125	140	150	155
	ES65-20 15002	3" x 2.5"	20	15		380/660	Hm (mss)	33	31	27	20
ES65-20 18502	25		18,5	44	40			34	28	22	15
ES65-20 22002	30		22	48	44			38	32	26	17
ES65-20 30002	40		30	57	53			48	43	36	25
ES65-20 37002	50		37	63	61			56	50	44	31

TİP TYPE	Bağlantı Giriş x Çıkış Inlet x Outlet	MOTOR			m ³ /h Hm (mss)	Debi (Q) - Capacity					
		HP	kW	V		30	50	125	150	155	160
	ES65-26 22002	3" x 2.5"	30	22		380 / 660	Hm (mss)	59	58	43	25
ES65-26 30002	40		30	65	64			52	39	32	12
ES65-26 37002	50		37	81	80			67	55	50	40
ES65-26 45002	60		45	91	90			88	72	66	60
ES65-26 55002	75		55	99	98			90	80	76	70

TİP TYPE	Bağlantı Giriş x Çıkış Inlet x Outlet	MOTOR			m ³ /h Hm (mss)	Debi (Q) - Capacity					
		HP	kW	V		90	125	145	150	155	160
	ES65-32 45002	3" x 2.5"	60	45		380/660	Hm (mss)	81	75	60	54
ES65-32 55002	75		55	95	88			70	63	54	43
ES65-32 75002	100		75	120	106			80	70	60	47
ES65-32 90002	125		90	132	120			106	100	90	85



ES65 (3000 d/d) (Yumuşak veya Mekanik Salmastralı) **SALYANGOZ KAPLINLİ POMPALAR**

VOLUTE CASING LONG-COUPLED PUMPS (Soft Packing / Mechanical Seal)

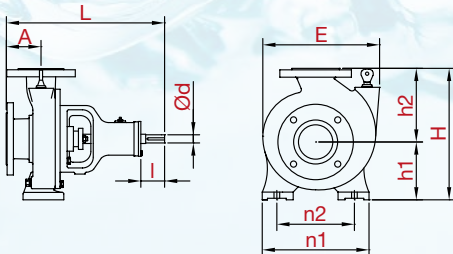
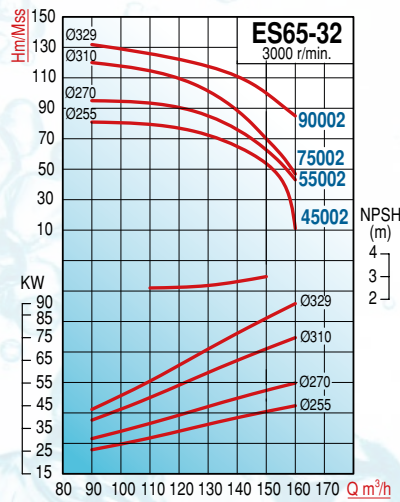
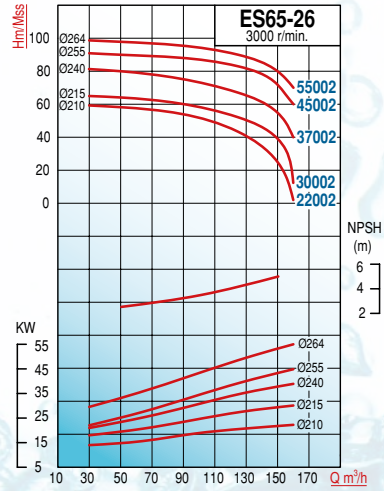
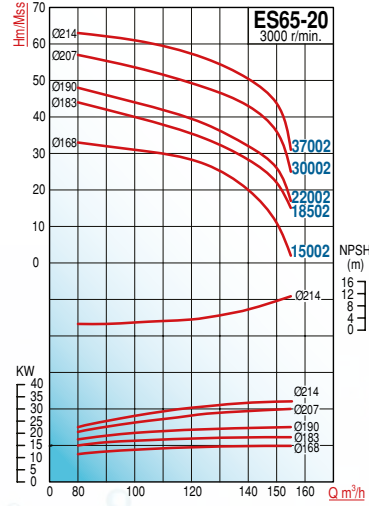
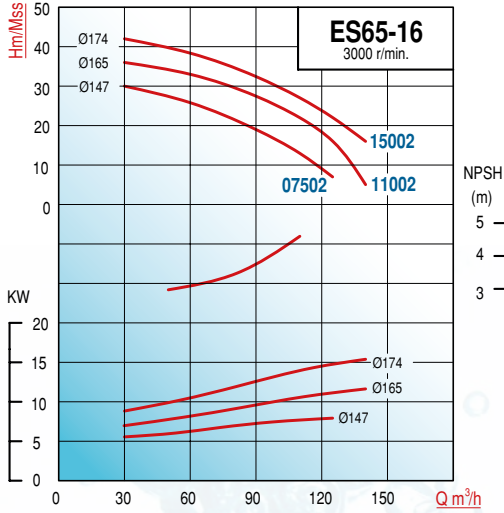

TİP TYPE	Boyutlar - Dimensions (mm)										Ağırlık - Weight
	A	L	h1	h2	H	E	n1	n2	l	d	Kg
ES65-16	100	460	160	180	340	285	280	212	50	24	47
ES65-20	100	460	180	225	405	335	320	250	55	24	52
ES65-26	100	570	200	250	450	375	360	280	84	32	81
ES65-32	125	595	225	280	505	415	400	315	84	32	106



ES80 (3000 d/d) (Yumuşak veya Mekanik Salmastralı) SALYANGOZ KAPLINLİ POMPALAR

VOLUTE CASING LONG-COUPLED PUMPS (Soft Packing / Mechanical Seal)

TİP TYPE	Bağlantı	MOTOR			m ³ /h	Debi (Q) - Capacity						
	Giriş x Çıkış	HP	kW	V		Hm (mSS)	70	100	130	160	190	220
	Inlet x Outlet											
ES80-16 11002	4"x3"	15	11	380/660	Hm (mSS)		26	25	23	19	13	
ES80-16 15002		20	15			30	29	28	25	20	13	
ES80-16 18502		25	18,5			34	33	32	29	25	18	
ES80-16 22002		30	22			38	37	36	33	29	23	

TİP TYPE	Bağlantı	MOTOR			m ³ /h	Debi (Q) - Capacity						
	Giriş x Çıkış	HP	kW	V		Hm (mSS)	90	120	150	180	210	240
	Inlet x Outlet											
ES80-20 18502	4" x 3"	25	18,5	380 / 660	Hm (mSS)		41	39	35	29	20	
ES80-20 22002		30	22			47	46	44	40	33		
ES80-20 30002		40	30			53	52	50	46	40	32	
ES80-20 37002		50	37			58	57	55	52	47	40	
ES80-20 45002		60	45			64	63	62	59	54	46	

TİP TYPE	Bağlantı	MOTOR			m ³ /h	Debi (Q) - Capacity						
	Giriş x Çıkış	HP	kW	V		Hm (mSS)	70	100	130	160	190	220
	Inlet x Outlet											
ES80-26 30002	4" x 3"	40	30	380 / 660	Hm (mSS)		59	58	55	50	41	
ES80-26 37002		50	37			64	63	61	57	49		
ES80-26 45002		60	45			70	69	67	63	57	48	
ES80-26 55002		75	55			81	80	78	74	68	60	
ES80-26 75002		100	75			99	98	95	91	86	80	



ES80 (3000 d/d) (Yumuşak veya Mekanik Salmastralı) **SALYANGOZ KAPLINLİ POMPALAR**

VOLUTE CASING LONG-COUPLED PUMPS (Soft Packing / Mechanical Seal)

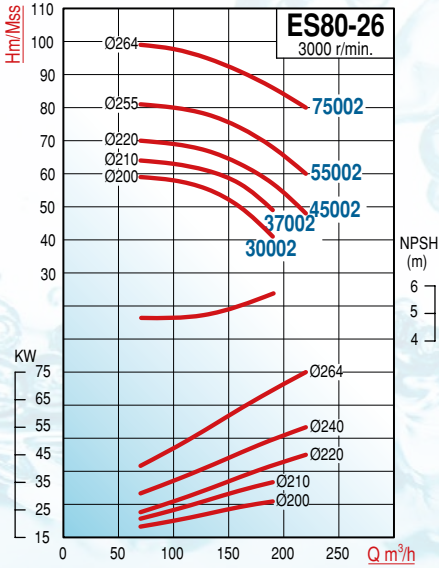
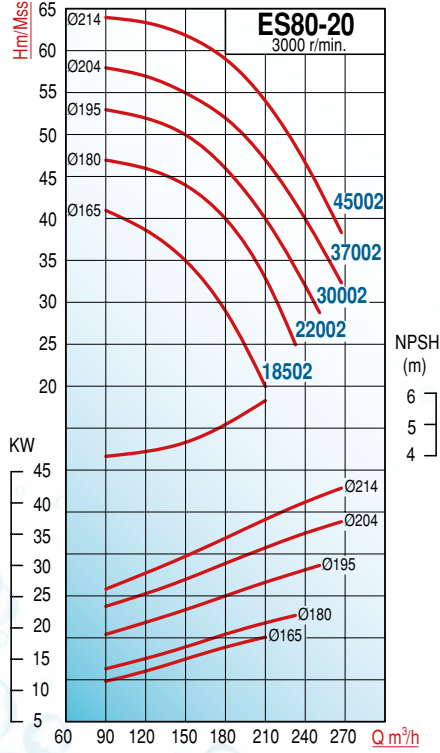
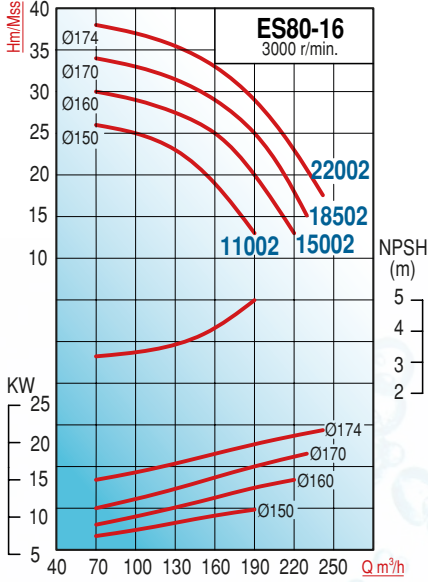

TİP TYPE	Boyutlar - Dimensions (mm)										Ağırlık - Weight
	A	L	h1	h2	H	E	n1	n2	l	d	Kg
ES80-16	125	485	180	225	405	350	320	250	50	24	51
ES80-20	125	595	180	250	430	385	345	280	84	32	65
ES80-26	125	595	200	280	480	420	400	315	84	32	86
ES80-32	125	595	250	315	565	445	400	315	84	32	92

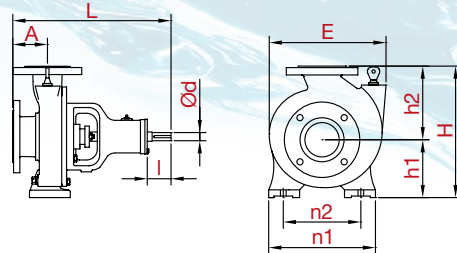

ES100 (3000 d/d) (Yumuşak veya Mekanik Salmastralı) SALYANGOZ KAPLINLİ POMPALAR

VOLUTE CASING LONG-COUPLED PUMPS (Soft Packing / Mechanical Seal)

TİP TYPE	Bağlantı Giriş x Çıkış Inlet x Outlet	MOTOR			m ³ /h	Debi (Q) - Capacity					
		HP	kW	V		120	160	200	240	280	300
ES100-20 30002	5" x 4"	40	30	380 / 660	Hm (mSS)	43	41	38	35	30	
ES100-20 37002		50	37			49	47	44	41	36	30
ES100-20 45002		60	45			55	53	51	47	42	35
ES100-20 55002		75	55			63	61	58	54	50	44

TİP TYPE	Bağlantı Giriş x Çıkış Inlet x Outlet	MOTOR			m ³ /h	Debi (Q) - Capacity					
		HP	kW	V		70	160	200	240	280	320
ES100-26 55002	5" x 4"	75	55	380 / 660	Hm (mSS)	68	67	63	56	44	
ES100-26 75002		100	75			81	80	77	72	64	52
ES100-26 90002		125	90			100	98	97	95	93	90

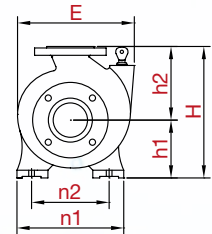
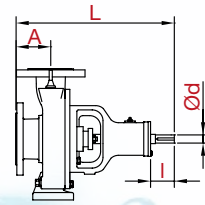
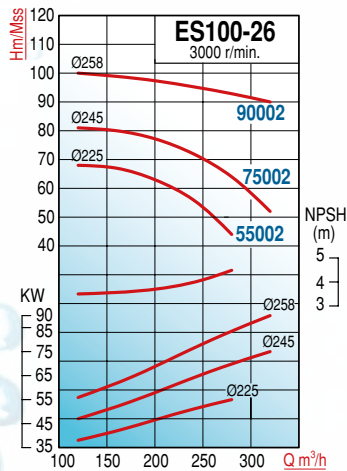
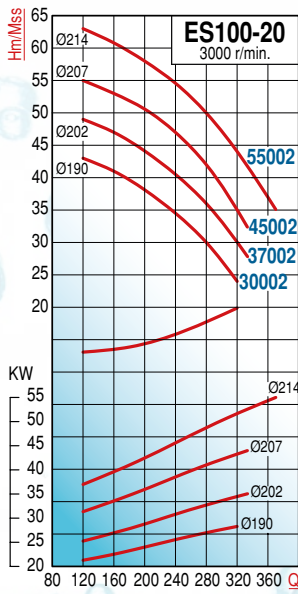

TİP TYPE	Boyutlar - Dimensions (mm)										Ağırlık - Weight Kg
	A	L	h1	h2	H	E	n1	n2	l	d	
ES100-20	125	595	200	280	480	385	360	280	84	32	75
ES100-26	140	610	225	280	505	420	400	315	84	32	96

ES40 (1500 d/d) (Yumuşak veya Mekanik Salmastralı) SALYANGOZ KAPLINLİ POMPALAR

1500 d/d

VOLUTE CASING LONG-COUPLED PUMPS (Soft Packing / Mechanical Seal)

TİP TYPE	Bağlantı Giriş x Çıkış Inlet x Outlet	MOTOR			m ³ /h	Debi (Q) - Capacity						
		HP	kW	V		Hm (mSS)	4	8	12	15	18	23
							8,5	8	7,5	6,5	2	
ES40-16 00554	2.5"x1.5"	0,75	0,55	380	Hm (mSS)	11	10,5	10	9	8	3	
ES40-16 00754		1	0,75			12,5	12	11,5	11	10,5	8,5	
ES40-16 01104		1,5	1,1									

TİP TYPE	Bağlantı Giriş x Çıkış Inlet x Outlet	MOTOR			m ³ /h	Debi (Q) - Capacity						
		HP	kW	V		Hm (mSS)	8	12	14	16	18	20
							10	9,5	9	8	7	
ES40-20 00754	2.5" x 1.5"	1	0.75	380	Hm (mSS)	13.5	13	12.5	11.5	10.5	9	
ES40-20 01104		1.5	1.1			16	15.5	15	14	13	11.5	
ES40-20 01504		2	1.5									

TİP TYPE	Bağlantı Giriş x Çıkış Inlet x Outlet	MOTOR			m ³ /h	Debi (Q) - Capacity						
		HP	kW	V		Hm (mSS)	9	12	15	18	23	25
							12	11.5	11	10		
ES40-26 01104	2.5" x 1.5"	1.5	1.1	380	Hm (mSS)	16	15	14.5	13.5	11		
ES40-26 01504		2	1.5			20	19.5	19	18	15.5		
ES40-26 02204		3	2.2			24.5	24	23.5	22.5	19.5	18	
ES40-26 03004		4	3									

TİP TYPE	Bağlantı Giriş x Çıkış Inlet x Outlet	MOTOR			m ³ /h	Debi (Q) - Capacity						
		HP	kW	V		Hm (mSS)	10	14	18	22	26	30
							20	19	17	14		
ES40-32 02204	2.5" x 1.5"	3	2.2	380	Hm (mSS)	26	25	23	20.5	16		
ES40-32 03004		4	3			31	30	28.5	26	23	17	
ES40-32 04004		5.5	4	380/660		Hm (mSS)	38	37	35	32	28	23
ES40-32 05504		7.5	5.5									



ES40 (1500 d/d) (Yumuşak veya Mekanik Salmastralı) SALYANGOZ KAPLINLİ POMPALAR

1500 d/d

VOLUTE CASING LONG-COUPLED PUMPS (Soft Packing / Mechanical Seal)

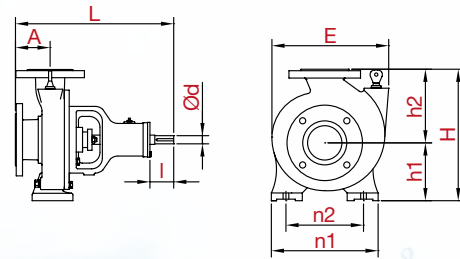
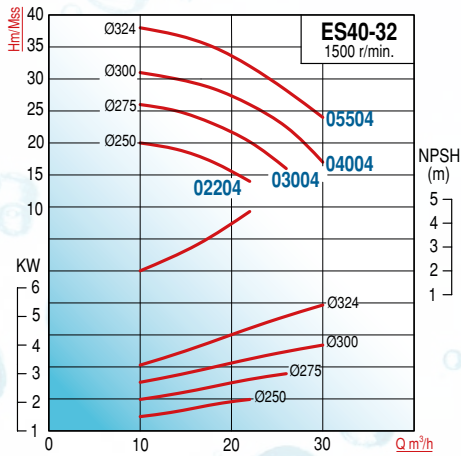
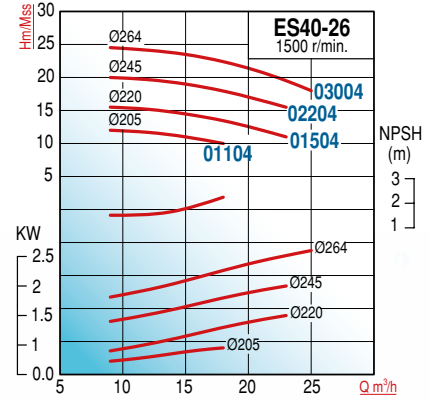
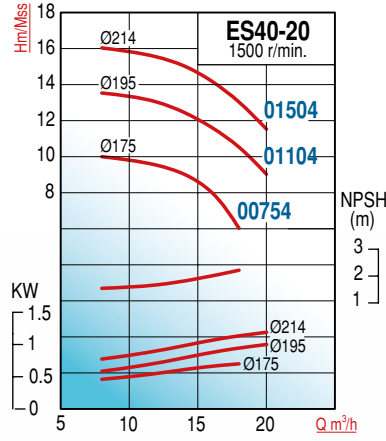
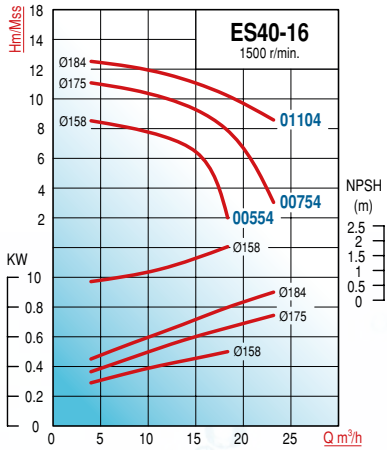

TİP TYPE	Boyutlar - Dimensions (mm)										Ağırlık - Weight	
	A	L	h1	h2	H	E	n1	n2	I	d	Kg	
ES40-16	80	445	132	160	192	246	240	190	55	24	35	
ES40-20	100	460	160	180	340	290	265	212	55	24	42	
ES40-26	100	460	180	225	405	340	320	250	55	24	59	
ES40-32	125	595	200	250	450	400	345	280	80	32	87	

ES50 (1500 d/d) (Yumuşak veya Mekanik Salmastralı) **SALYANGOZ KAPLINLİ POMPALAR**

1500 d/d

VOLUTE CASING LONG-COUPLED PUMPS (Soft Packing / Mechanical Seal)

TİP TYPE	Bağlantı Giriş x Çıkış Inlet x Outlet	MOTOR			m ³ /h	Debi (Q) - Capacity						
		HP	kW	V		Hm (mSS)	5	10	15	20	25	30
							8,5	8	8	7	6	
ES50-16 00754	2.5" x 2"	1	0,75	380	Hm (mSS)	8,5	8	8	7	6		
ES50-16 01104		1,5	1,1			10	10	9,5	9	8,5	7,5	
ES50-16 01504		2	1,5			11,5	11,5	11	10,5	9,5	9	

TİP TYPE	Bağlantı Giriş x Çıkış Inlet x Outlet	MOTOR			m ³ /h	Debi (Q) - Capacity						
		HP	kW	V		Hm (mSS)	15	20	25	30	35	40
							10,5	10	9	8		
ES50-20 01104	2.5" x 2"	1.5	1.1	380	Hm (mSS)	10,5	10	9	8			
ES50-20 01504		2	1.5			12,5	12,2	11,5	10,5	9,5		
ES50-20 02204		3	2.2			15	14,5	14	13,5	12,5	11	
ES50-20 03004		4	3			16,5	16	15,5	15	14	12,5	

TİP TYPE	Bağlantı Giriş x Çıkış Inlet x Outlet	MOTOR			m ³ /h	Debi (Q) - Capacity						
		HP	kW	V		Hm (mSS)	15	25	30	35	40	50
							15,5	14,5	13	11		
ES50-26 02204	2.5" x 2"	3	2,2	380	Hm (mSS)	15,5	14,5	13	11			
ES50-26 03004		4	3			19,5	19	18	16,5	14,5		
ES50-26 04004		5,5	4			22,5	22	21,5	21	20	17	
ES50-26 05504		7,5	5,5	24,5		24	23,5	23	22	19		

TİP TYPE	Bağlantı Giriş x Çıkış Inlet x Outlet	MOTOR			m ³ /h	Debi (Q) - Capacity						
		HP	kW	V		Hm (mSS)	15	25	35	45	55	65
							25	24	22	19,5	16	
ES50-32 04004	2.5" x 2"	5,5	4	380 / 660	Hm (mSS)	25	24	22	19,5	16		
ES50-32 05504		7,5	5,5			29	28	26,5	24	21		
ES50-32 07504		10	7,5			34	33	31	29	26	22	
ES50-32 11004		15	11			37	36	34,5	32	29,5	25	



ES50 (1500 d/d) (Yumuşak veya Mekanik Salmastralı) SALYANGOZ KAPLINLİ POMPALAR

1500 d/d

VOLUTE CASING LONG-COUPLED PUMPS (Soft Packing / Mechanical Seal)

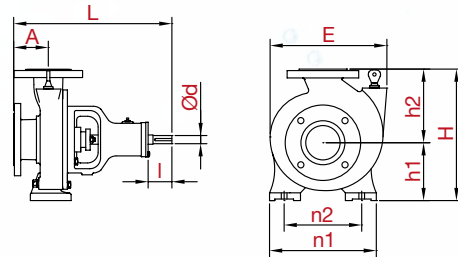
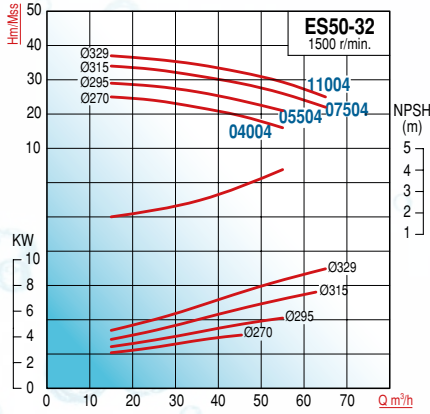
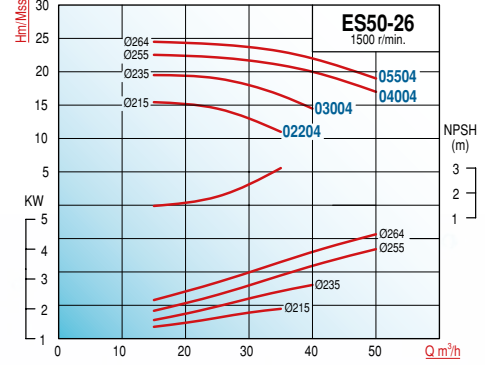
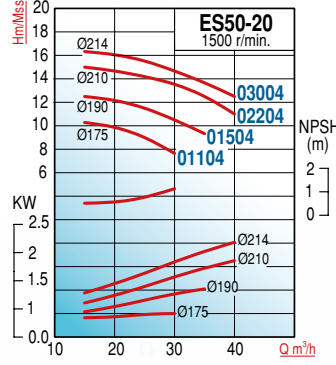
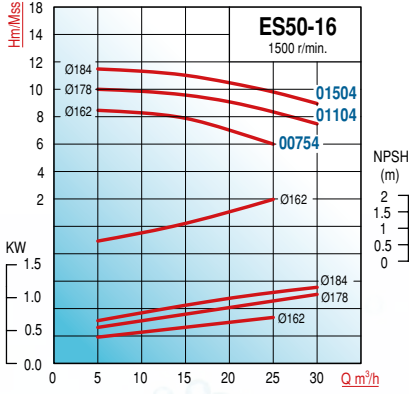

TİP TYPE	Boyutlar - Dimensions (mm)										Ağırlık - Weight
	A	L	h1	h2	H	E	n1	n2	I	d	Kg
ES50-16	100	465	160	180	340	271	265	212	55	24	40
ES50-20	100	460	160	200	360	305	265	212	55	24	47
ES50-26	100	460	180	225	405	335	320	250	55	24	62
ES50-32	125	595	225	280	507	417	345	280	80	32	90

ES65 (1500 d/d) (Yumuşak veya Mekanik Salmastralı) SALYANGOZ KAPLINLİ POMPALAR

1500 d/d

VOLUTE CASING LONG-COUPLED PUMPS (Soft Packing / Mechanical Seal)

TİP TYPE	Bağlantı Giriş x Çıkış Inlet x Outlet	MOTOR			m ³ /h	Debi (Q) - Capacity					
		HP	kW	V		10	20	30	40	50	60
		ES65-16 01104	3"x2.5"	1,5		1,1	380	Hm(mSS)	8	7,5	7
ES65-16 01504	2	1,5		9	8,5	8			7,5	6	4
ES65-16 02204	3	2,2		11,5	11	10,5			10	9	8

TİP TYPE	Bağlantı Giriş x Çıkış Inlet x Outlet	MOTOR			m ³ /h	Debi (Q) - Capacity					
		HP	kW	V		15	30	45	60	75	90
		ES65-20 01504	3" x 2.5"	2		1.5	380	Hm (mSS)	9	8.5	7
ES65-20 02204	3	2.2		11	10.5	9.5			7.5		
ES65-20 03004	4	3		14	13.5	12.5			11	8.5	
ES65-20 04004	5.5	4		380/ 660	16	15.5	14.5		13	11	8

TİP TYPE	Bağlantı Giriş x Çıkış Inlet x Outlet	MOTOR			m ³ /h	Debi (Q) - Capacity					
		HP	kW	V		20	35	45	55	65	75
		ES65-26 03004	3" x 2.5"	4		3	380	Hm (mSS)	16	15.5	14.5
ES65-26 04004	5.5	4		380 / 660	19.5	19	17.5		16	14	
ES65-26 05504	7.5	5.5			22.5	22	21		20	19	17.5
ES65-26 07504	10	7.5			25	24.5	24		23	22	20

TİP TYPE	Bağlantı Giriş x Çıkış Inlet x Outlet	MOTOR			m ³ /h	Debi (Q) - Capacity					
		HP	kW	V		30	45	60	75	90	105
		ES65-32 05504	3" x 2.5"	7.5		5.5	380/660	Hm (mSS)	22	21	19
ES65-32 07504	10	7.5		27.5	27	25.5			22.5	15	
ES65-32 11004	15	11		34	33	31			28	22.5	13
ES65-32 15004	20	15		37.5	36.5	35			32.5	27.5	20



ES65 (1500 d/d) (Yumuşak veya Mekanik Salmastralı) SALYANGOZ KAPLINLİ POMPALAR

1500 d/d

VOLUTE CASING LONG-COUPLED PUMPS (Soft Packing / Mechanical Seal)

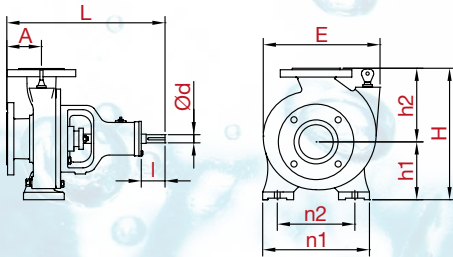
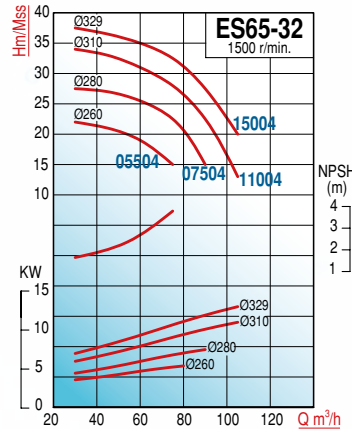
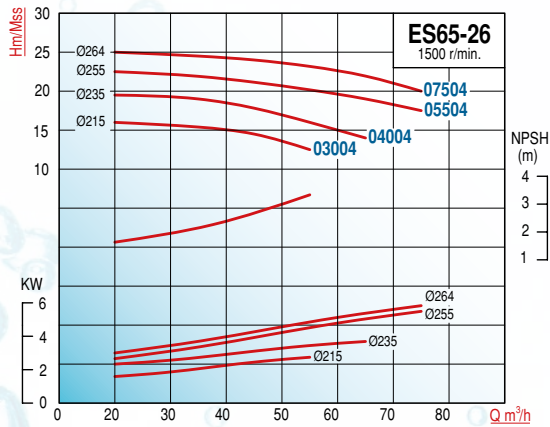
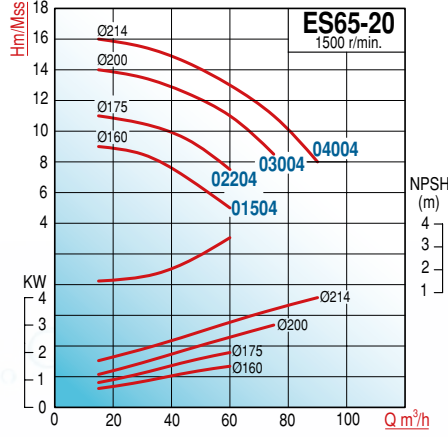
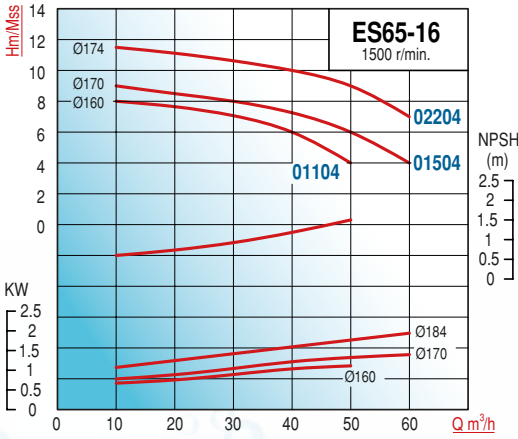

TİP TYPE	Boyutlar - Dimensions (mm)										Ağırlık - Weight	
	A	L	h1	h2	H	E	n1	n2	i	d	Kg	
ES65-16	100	460	160	180	340	285	280	212	50	24	47	
ES65-20	100	460	180	225	405	335	320	250	55	24	52	
ES65-26	100	570	200	250	450	375	360	280	84	32	81	
ES65-32	125	595	225	280	505	415	400	315	84	32	106	

ES80 (1500 d/d) (Yumuşak veya Mekanik Salmastralı) SALYANGOZ KAPLINLİ POMPALAR

1500 d/d

VOLUTE CASING LONG-COUPLED PUMPS (Soft Packing / Mechanical Seal)

TİP TYPE	Bağlantı Giriş x Çıkış Inlet x Outlet	MOTOR			m ³ /h	Debi (Q) - Capacity					
		HP	kW	V		30	40	50	60	70	80
		ES80-16 01504	4" x 3"	2		1,5	380	Hm (mSS)	8,5	7,5	6,5
ES80-16 02204	3	2,2		10,5	10	9,5			8,5	7,5	6
ES80-16 03004	4	3		12	11,5	11			10	9	7,5

TİP TYPE	Bağlantı Giriş x Çıkış Inlet x Outlet	MOTOR			m ³ /h	Debi (Q) - Capacity					
		HP	kW	V		40	55	70	85	100	115
		ES80-20 03004	4" x 3"	4		3	380	Hm (mSS)	11	10,5	10
ES80-20 04004	5,5	4		380/660	13	12,5	12		11,5	10,5	
ES80-20 05504	7,5	5,5		380/660	15,5	15	14,5		14	13	12

TİP TYPE	Bağlantı Giriş x Çıkış Inlet x Outlet	MOTOR			m ³ /h	Debi (Q) - Capacity					
		HP	kW	V		40	60	80	100	115	130
		ES80-26 04004	4" x 3"	5,5		4	380/660	Hm (mSS)	15	14,5	13,5
ES80-26 05504	7,5	5,5		17,5	17	16			15	13	
ES80-26 07504	10	7,5		21,5	21	20			18,5	16,5	14
ES80-26 11004	15	11		24,5	24	23,5			22	20,5	18,5

TİP TYPE	Bağlantı Giriş x Çıkış Inlet x Outlet	MOTOR			m ³ /h	Debi (Q) - Capacity					
		HP	kW	V		40	60	80	100	115	130
		ES80-32 07504	4" x 3"	10		7,5	380/660	Hm (mSS)	23	22	20
ES80-32 11004	15	11		30	29	27			25	19	
ES80-32 15004	20	15		35	34	33			31	27	21
ES80-32 18504	25	18,5		37,5	37	36			35	32	26



ES80 (1500 d/d) (Yumuşak veya Mekanik Salmastralı) SALYANGOZ KAPLINLİ POMPALAR

1500 d/d

VOLUTE CASING LONG-COUPLED PUMPS (Soft Packing / Mechanical Seal)

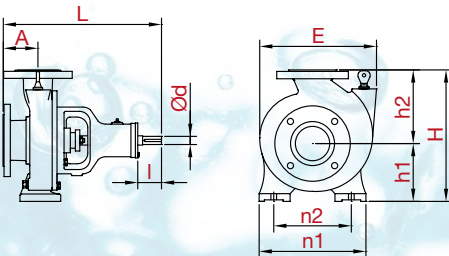
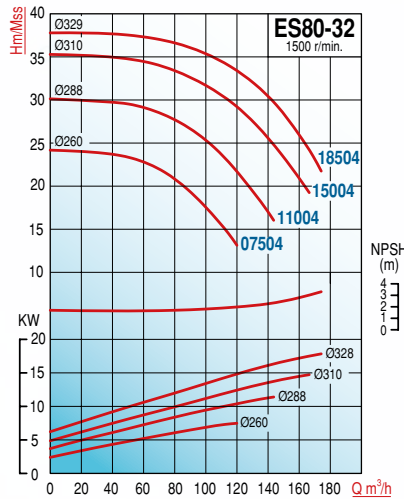
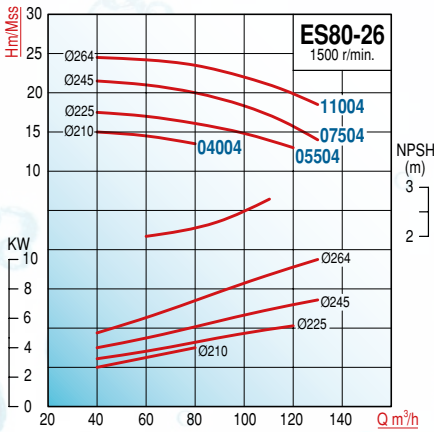
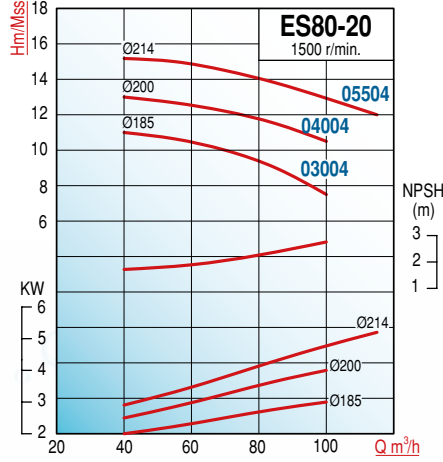
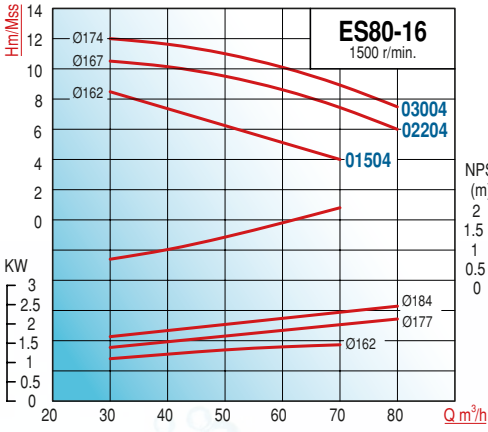

TİP TYPE	Boyutlar - Dimensions (mm)										Ağırlık - Weight
	A	L	h1	h2	H	E	n1	n2	l	d	Kg
ES80-16	125	485	180	225	405	350	320	250	50	24	51
ES80-20	125	595	180	250	430	385	345	280	84	32	65
ES80-26	125	595	200	280	480	420	400	315	84	32	86
ES80-32	125	595	250	315	565	445	400	315	84	32	92

ES100 (1500 d/d) (Yumuşak veya Mekanik Salmastralı) **SALYANGOZ KAPLINLİ POMPALAR**

1500 d/d

VOLUTE CASING LONG-COUPLED PUMPS (Soft Packing / Mechanical Seal)

TİP TYPE	Bağlantı	MOTOR			m ³ /h	Debi (Q) - Capacity						
	Giriş x Çıkış	HP	kW	V		Hm (mSS)	50	80	110	140	160	180
	Inlet x Outlet											
ES100-20 03004	5" x 4"	4.0	3	380	Hm (mSS)							
ES100-20 04004		5.5	4	380 / 660		12	11.5	10.5	8.5	7		
ES100-20 05504		7.5	5.5			14	13.5	13	11.5	10	8.5	
ES100-20 07504		10	7.5			16	15.5	15	13.5	12	10	

TİP TYPE	Bağlantı	MOTOR			m ³ /h	Debi (Q) - Capacity						
	Giriş x Çıkış	HP	kW	V		Hm (mSS)	75	100	125	150	175	200
	Inlet x Outlet											
ES100-26 05504	5" x 4"	7.5	5.5	380 / 660	Hm (mSS)							
ES100-26 07504		10	7.5			17.5	17	16	14			
ES100-26 11004		15	11			21.5	21	20.5	19.5	18		
ES100-26 15004		20	15			25	24.5	24	23	22	20	

TİP TYPE	Bağlantı	MOTOR			m ³ /h	Debi (Q) - Capacity						
	Giriş x Çıkış	HP	kW	V		Hm (mSS)	100	125	150	175	200	220
	Inlet x Outlet											
ES100-32 11004	5"x4"	15	11	380 / 660	Hm (mSS)							
ES100-32 15004		20	15			26	25	24	22	17		
ES100-32 18504		25	18,5			32	29	28	26	24	23	
ES100-32 22004		30	22			35	33	32	30	27	26	
ES100-32 30004		40	30			36	35	33	32	29	27	



ES100 (1500 d/d) (Yumuşak veya Mekanik Salmastralı)

SALYANGOZ KAPLINLİ POMPALAR

1500 d/d

VOLUTE CASING LONG-COUPLED PUMPS (Soft Packing / Mechanical Seal)

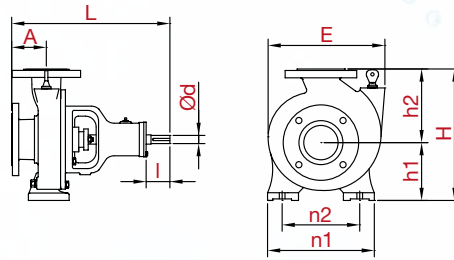
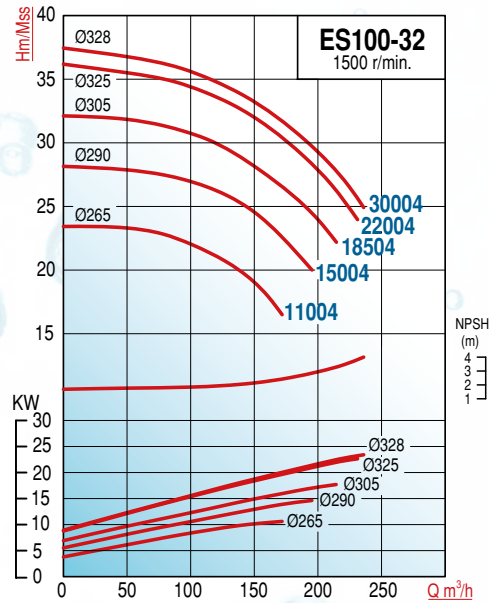
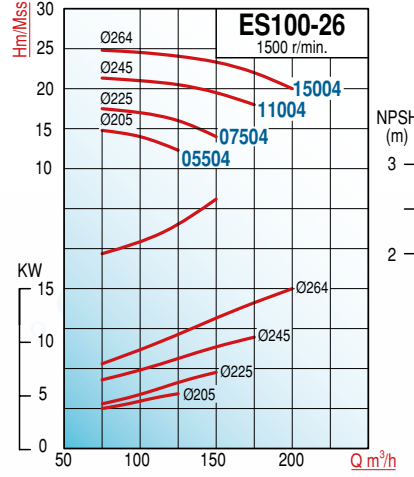
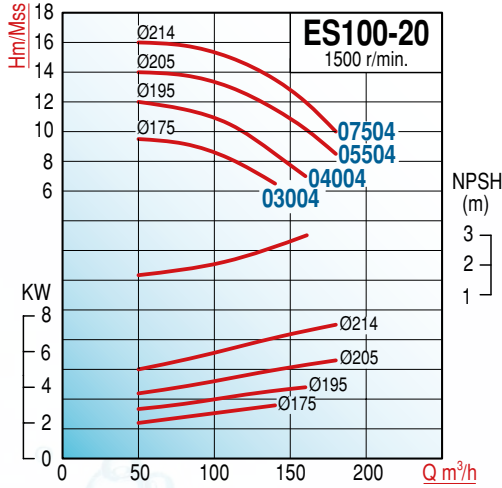

TİP TYPE	Boyutlar - Dimensions (mm)										Ağırlık - Weight
	A	L	h1	h2	H	E	n1	n2	I	d	Kg
ES100-20	125	595	200	280	480	385	360	280	84	32	75
ES100-26	140	610	225	280	505	420	400	315	84	32	96
ES100-32	140	610	250	315	565	485	400	315	84	32	100

BM

YATAY MİLLİ KADEMELİ POMPALAR

HORIZONTAL MULTISTAGE PUMPS

TİP TYPE	Bağlantı GirişÇıkış InletxOutlet	MOTOR						Kademe Stage	Hm m ³ /h	Debi (Q) - Capacity					
		HP	kW	V		A				1	2	3	4	5	6
				Mono	Tri	Mono	Tri								
BM2-9x5	1"x1"	1,5	1,1	220	-	6,2	-	5	Hm (mSS)	58	48	35	16		
BM2-9x6	1"x1"	1,5	1,1	220	-	6,2	-	6		67	56	40	22		
BM4-9x5	1"x1"	2	1,5	220	-	9,2	-	5		66	63	57	49	40	27
BM4-9x6	1"x1"	2	1,5	220	-	9,2	-	6		77	75	67	58	47	34

TEKNİK ÖZELLİKLERİ

- Çok kademeli
- Paslanmaz gövde (AISI 304)
- Monoblok
- Emici ve Verici gövde: Pık GG-25
- Mil: Paslanmaz çelik AISI 304
- Sızdırmazlık: Mekanik salmastra Ø16 (Karbon/Seramik/Nbr)
- Çark ve Difüzör: Noryl (PPO)
- Yataklama: Basma kısmı motor rulmanı
- Sıvı sıcaklığı: +5 °C ~ +70 °C
- Devir Hızı: 2900d/dak.
- İzolasyon sınıfı: F
- Koruma sınıfı: IP54
- Emme derinliği: 6.5mt.

TECHNICAL DATA

- Multi-Stage
- Pump body: S/S (AISI 304)
- Close-coupled
- Inlet & Outlet Section: Cast iron GG-25
- Shaft: S/S (AISI 304)
- Non-Leakage: Mechanical seal Ø16 (Karbon/Seramik/Nbr)
- Impeller & Diffuser: Noryl (PPO)
- Bearing: Ball bearing on delivery side
- Liquid Temp.: +5°C ~ +60°C
- Speed: 2900 rpm.
- Insulation Class: F
- Protection Class: IP54
- Suction lift: Max 6.5 m.



KULLANIM ALANLARI

- Hidrofor sistemleri
- Apartman ve konutlar
- İş merkezleri, okul
- Endüstriyel tesisler
- Yanıcı ve Patlayıcı içermeyen temiz ve lifsiz sıvılar.
- Yağmurlama ve sprinkli sulama sistemleri

APPLICATIONS

- Booster systems
- Residences
- Business centers, Schools
- Industry
- Irrigation,
- Sprinkler systems

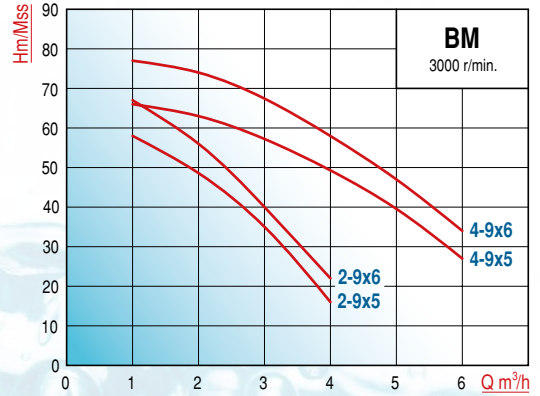

TİP TYPE	Boyutlar - Dimensions (mm)								Ağırlık - Weight
	A	L	h1	h2	H	n1	n2	n3	Kg
BM2-9x5	215	430	145	172	186	170	140	235	15
BM2-9x6	237	453	145	172	186	170	140	258	16
BM4-9x5	220	464	155	181	225	151	120	240	20
BM4-9x6	242	485	155	181	225	151	120	243	21

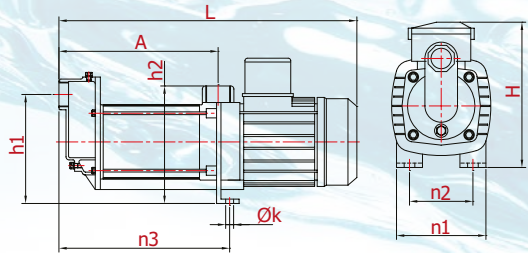

HMC DİK MİLLİ KADEMELİ POMPALAR

VERTICAL MULTISTAGE PUMPS

TİP TYPE	Bağlantı GirişÇıkış InletxOutlet	MOTOR				Kademe Stage	Hm m ³ /h	Debi (Q) - Capacity							
		HP	kW	V				A		1	2	3	5	7	8
				Mono	Tri			Mono	Tri						
HMC90-8SV	1"× 1"	2,2	1,65		380		8	93	86	77	49				
HMC145-8SV	1 ¼"×1"	3,3	2,5		380		8	103	100	96	80	52	36		
HMC-10VE	1 ¼"×1 ¼"	5	3,7		380		10	132	128	118	96	65	45		



TEKNİK ÖZELLİKLERİ

- Çok kademeli
- Paslanmaz gövde (AISI 304)
- Monoblok
- Emici ve Verici gövde: PİK GG-25
- Mil: Paslanmaz çelik AISI 304
- Sızdırmazlık: Mekanik salmastra Ø16 (Karbon/Seramik/Nbr)
- Çark: AISI 304 Paslanmaz
- Difüzör: Noryl (PPO)
- Yataklama: Basma kısmı motor rulmanı
- Sıvı sıcaklığı: +5 °C ~ +60 °C
- Devir Hızı: 2900d/dak.
- İzolasyon sınıfı: F
- Koruma sınıfı: IP54
- Emme derinliği: 6.5mt.

KULLANIM ALANLARI

- Hidrofor sistemleri
- Apartman ve konutlar
- İş merkezleri, okul
- Endüstriyel tesisler
- Yanıcı ve Patlayıcı içermeyen temiz ve lifsiz sıvılar.
- Yağmurlama ve sprinkli sulama sistemleri

TECHNICAL DATA

- Multi-Stage
- Pump body: S/S (AISI 304)
- Close-coupled
- Inlet & Outlet Section: Cast iron GG-25
- Shaft: S/S (AISI 304)
- Non-Leakage: Mechanical seal Ø16 (Karbon/Seramik/Nbr)
- Impeller: S/S (AISI 304)
- Diffuser: Noryl (PPO)
- Bearing: Ball bearing on delivery side
- Liquid Temp.: +5°C ~ +60°C
- Speed: 2900 rpm.
- Insulation Class: F
- Protection Class: IP54
- Suction lift: Max 6.5 m.

APPLICATIONS

- Booster systems
- Residences
- Business centers, Schools
- Industry
- Irrigation,
- Sprinkler systems

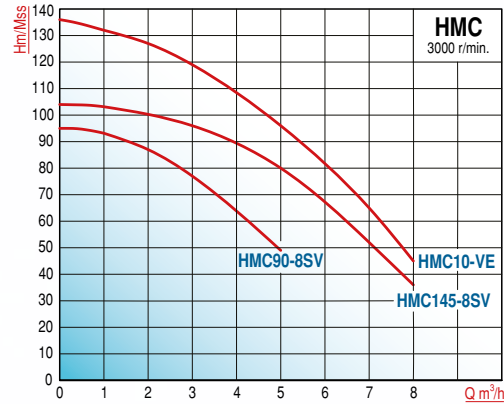

TİP TYPE	Boyutlar - Dimensions (mm)					Ağırlık - Weight
	L	h1	h2	H	E	Kg
HMC90-8SV	200	35	300	588	193	26
HMC145-8SV	206	35	300	620	215	30
HMC-10VE	184	35	335	735	215	35

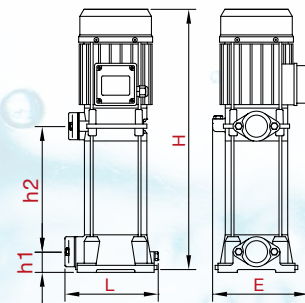

VM

DİK MİLLİ KADEMELİ POMPALAR

VERTICAL MULTISTAGE PUMPS

TİP TYPE	Bağlantı		MOTOR				Kademe Stage	m ³ /h	Debi (Q) - Capacity							
	GirişÇıkış		HP	kW	V				A		1	3	7	12	18	20
	Inlet	Outlet			Mono	Tri			Mono	Tri						
VM4-9x4	1 1/4" x 1"		1.5	1.1	220	380	6.2	2.4	4	53	50	40	20			
VM2-9x7	1 1/4" x 1 1/4"		1.5	1.1	220	380	6.8	2.9	7	80	65	35				
VM2-9x9	1 1/4" x 1 1/4"		2	1.5	220	380	9.6	3.5	9	108	87	45				
VM4-9x6	1 1/4" x 1 1/4"		2	1.5	-	380	-	3.5	6	80	76	63	35			
VM4-9x8	1 1/4" x 1 1/4"		3	2.2	-	380	-	5.3	8	99	98	82	45			
VM12-8.5x6	1.5" x 1.5"		4	3	-	380	-	6.5	6	66	65	63	54	34	25	
VM12-8.5x8	1.5" x 1.5"		6,3	4,7	-	380	-	9,6	8	87	85	77	66	42	30	
VM14-4	1.5" x 1.5"		4	3	-	380	-	6,5	4	70	69	67	61	46	29	



TEKNİK ÖZELLİKLERİ

- Çok kademeli
- Paslanmaz gövde (AISI 304)
- Monoblok
- Emici ve Verici gövde: PİK GG-25
- Mil: Paslanmaz çelik AISI 304
- Sızdırmazlık: Mekanik salmastra (VM4-4): Ø16 (Karbon/Seramik/Viton) (VM2-7, VM2-9, VM4-6, VM4-8, VM12-6): Ø19 (Karbon/Seramik/Viton) (VM14-4): Ø20 (Karbon/Seramik/Epdm)
- Çark ve Difüzör: Noryl (PPO)
- Yataklama: Emici Gövdede bronz burç, basış tarafı motor rulmanı
- Sıvı sıcaklığı: +5 °C ~ +60 °C
- Devir Hızı: 2900d/dak.
- İzolasyon sınıfı: F
- Koruma sınıfı: IP54
- Emme derinliği: 6.5mt.

TECHNICAL DATA

- Multi-Stage
- Pump body: S/S (AISI 304)
- Close-coupled
- Inlet & Outlet Section: Cast iron GG-25
- Shaft: S/S (AISI 304)
- Non-Leakage: Mechanical seal (VM4-4): Ø16 (Karbon/Seramik/Viton) (VM2-7, VM2-9, VM4-6, VM4-8, VM12-6): Ø19 (Karbon/Seramik/Viton) (VM14-4): Ø20 (Karbon/Seramik/Epdm)
- Impeller & Diffuser: Noryl (PPO)
- Bearing: Water lubricated bronze sleeve on suction section, ball bearing on delivery side
- Liquid Temp.: +5°C ~ +60°C
- Speed: 2900 rpm.
- Protection Class: IP54
- Insulation Class: F
- Suction lift: Max 6.5 m.

KULLANIM ALANLARI

- Hidrofor sistemleri
- Apartman ve konutlar
- İş merkezleri, okul
- Endüstriyel tesisler
- Yanıcı ve Patlayıcı içermeyen temiz ve lıfatsız sıvılar.
- Yağmurlama ve sprinkli sulama sistemleri

APPLICATIONS

- Booster systems
- Residences
- Business centers, Schools
- Industry
- Irrigation,
- Sprinkler systems

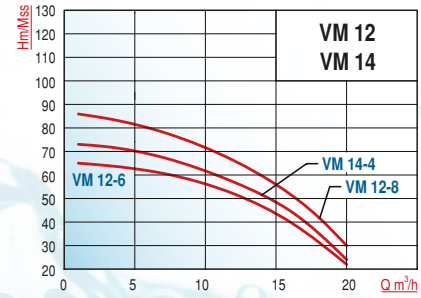
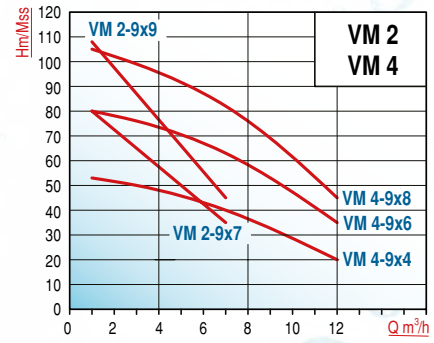

TİP TYPE	Boyutlar - Dimensions (mm)					Ağırlık - Weight
	L	h1	h2	H	E	Kg
VM4-9x4	192	44	169	430	182	18
VM2-9x7	192	44	249	538	182	19
VM2-9x9	192	44	297	586	182	24
VM4-9x6	192	44	225	514	182	20
VM4-9x8	192	44	273	562	182	23
VM12-8.5x6	192	44	311	640	182	30
VM12-8.5x8	192	44	410	760	182	33
VM14-4	315	44	220	570	195	34

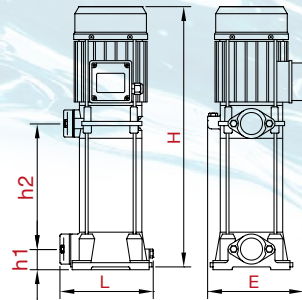

Dalgıç/Drenaj Pompalar

Submersible/Drainage Pumps



VF

DALGIÇ PİS SU (DRENAJ) POMPALARI

SUBMERSIBLE WASTE WATER (DRAINAGE) PUMPS

PARÇALAYICI YARI AÇIK ÇARKLI / SEMI OPEN CUTTER IMPELLER

TİP TYPE	Çıkış Ağızı Outlet	MOTOR				d/d	m ³ /h	Debi (Q) - Capacity						
		HP	kW	V	A			6	12	18	21	24	30	36
				Tri	Tri									
VF24-23	2"	3	2,2	380	4	2850	Hm (mSS)	20	19	17	17	16	13	10
VF24-24	2"	4	3	380	6,1	2850		29	26	24	22	20	16	

*LEDLİ ELEKTRONİK PANO + FLATÖR OPSİYONELDİR.



TİP TYPE	Çıkış Ağızı Outlet	MOTOR				d/d	m ³ /h	Debi (Q) - Capacity							
		HP	kW	V	A			6	18	30	42	54	72	84	
				Tri	Tri										
VF50-455	4"	5,5	4	380	8,6	2850	Hm (mSS)	21	18	17	16	15	13	11	
VF48-475	4"	7,5	5,5	380	9,6	2850		26	23	22	21	18	16	14	
VF48-310	3"	10	7,5	380	14,1	2850		39	35	32	30	27	23	16	
VF65-410	4"	10	7,5	380	14,1	2850		32	30	27	26	24	21	19	



TİP TYPE	Çıkış Ağızı Outlet	MOTOR				d/d	m ³ /h	Debi (Q) - Capacity						
		HP	kW	V	A			0	50	75	100	120	150	180
				Tri	Tri									
VF100-415	4"	15	11	380	18	1450		28	27	26	25	19		
VF100-610	6"	10	7,5	380	14,1	2850		18	15	14	10	9	2	
VF150-615	6"	15	11	380	23	1450						18	14	12

*LEDLİ ELEKTRONİK PANO + FLATÖR OPSİYONELDİR.

TİP TYPE	Çıkış Ağızı Outlet	MOTOR				d/d	m ³ /h	Debi (Q) - Capacity						
		HP	kW	V	A			270	280	290	300	310	320	330
				Tri	Tri									
VF300-815	8"	15	11	380	23	1450	Hm (mSS)	9	8,5	8	7	5	4	3

DALDIRMA DERİNLİĞİ (mSS): 5 mSS

*LEDLİ ELEKTRONİK PANO + FLATÖR OPSİYONELDİR.



DAR ALAN FLATÖRÜ

TİP TYPE
5 mt. Kablolu
10 mt. Kablolu



Not: Dar Alan Çalışma Kabiliyetli Flatör Opsiyoneldir.

VF

DALGIÇ PİS SU (DRENAJ) POMPALARI

SUBMERSIBLE WASTE WATER (DRAINAGE) PUMPS

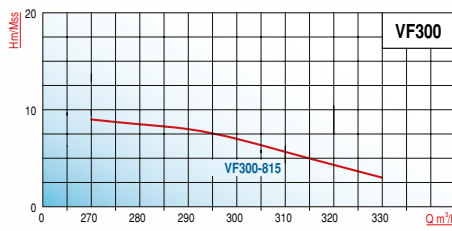
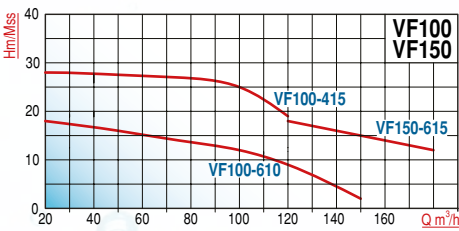
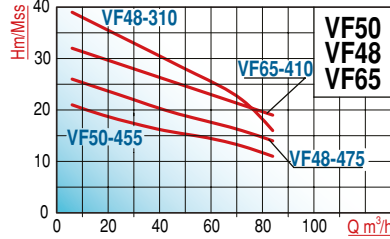
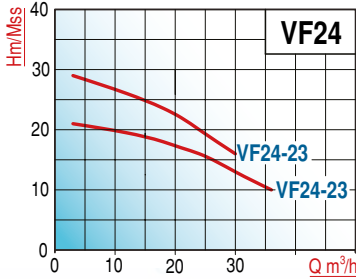

TEKNİK ÖZELLİKLER

- Çark: GG-25 PİK Döküm (VF24, VF48, VF50, VF65, VF100, VF150): Yarı Açık Çarklı (VF12, VF15, VF25): Kapalı Çarklı
- Sızdırmazlık: Yağ banyolu Silisyum Çift Mekanik Salmastra ve Yağ Keçesi. Yüzeyler: Karbon/Seramik/Silisyum/Silisyum/NBR (VF50, VF48, VF25): Ø25 VF15: Ø30 VF65, VF12, VF100(10 HP): Ø35 VF100 (15HP), VF150: Ø40
- Motor Gövdesi: GG-25 pik döküm / Pompa Gövdesi, Çark: GG-25 pik döküm
- Sıvı Sıcaklığı: +5 °C ~ +40 °C
- Devir Hızı: 2900d/dak.
- İzolasyon sınıfı: F
- Koruma sınıfı: IP68
- Frekans: 50Hz
- Suya dalma derinliği: Max: 5mt.

KULLANIM ALANLARI

- Kanalizasyon ve Çamurlu sular
- Yağmur suyu drenajı
- Evsel atık sular
- Lifli ve katı parçalı sıvılar
- Endüstriyel atıklar
- Apartments, oteller, fabrikalar
- Tarımsal Sulama
- Arıtma tesisleri

TECHNICAL DATA

- Impeller: Cast Iron GG-25 (VF24, VF48, VF50, VF65, VF100, VF150): Semi Open Impeller (VF12, VF15, VF25): Closed Impeller
- Sealing: High quality double mechanical seal running in oil bath with oil seal Surfaces: Carbon/Ceramic/Sic/Sic/NBR, (VF50, VF48, VF25): Ø25 VF15: Ø30 VF65, VF12, VF100(10 HP): Ø35 VF100 (15HP), VF150: Ø40
- Motor housing: GG-25 Iron casting / Pump Body, Impeller: GG-25 Iron casting
- Liquid Temp.: +5°C ~ +40°C
- Speed: 2900 rpm.
- Insulation Class: F
- Protection Class: IP68
- Frequency: 50Hz
- Immersion depth: Max 5 mt
- Max Solid diameter: Ø50mm.

APPLICATIONS

- Sewage and muddy water
- Rain water drainage systems
- Domestic waste waters
- Liquids containing fibrous and solid materials
- Industrial waste water
- Apartments, hotels, factories
- Irrigation
- Water treatment systems

TİP TYPE	Boyutlar - Dimensions (mm)			Ağırlık Weight Kg.
	Boy-L Length	Yük-H Height	En-W Width	
VF20-33	385	520	260	46
VF20-34	385	520	260	48
VF24-23	320	510	185	28
VF24-24	390	640	250	56
VF50-455	430	665	260	72
VF48-475	415	720	265	83
VF65-410	480	845	350	120
VF100-610	540	835	345	144
VF100-415	730	930	460	216
VF150-615	840	970	460	252
VF300-815				275
VF15-275	380	660	260	74
VF25-275	340	655	250	78
VF12-210	480	845	350	110

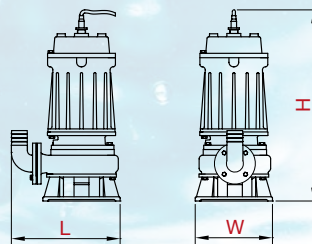

DRENAJ POMPALARI (Temiz ve Az Kirli Sular)

DRAINAGE PUMPS (Clean & Slightly Dirty Water)

TİP TYPE	ÇIKIŞ AĞIZI OUTLET	MOTOR				m ³ /h	DEBİ - CAPACITY (Q)						ÖZELLİK
		HP	kW	V	A		1	2	4	6	8	9	
VQDP-750AW	1"/1.5"	1	0,75	220	3,5	Hm(mSS)	9	8	7	6	4	3	PİS SU DRENAJI, GÖVDE&ÇARK: PLASTİK, Şamandıralı , 6 mt. Kablo ve Fişli
VQDS-750DW (Paslanmaz)	1"/1.5"	1	0,75	220	4,8		10	9	8	7	6	5	



VQDP



VQDS

TİP TYPE	ÇIKIŞ AĞIZI OUTLET	MOTOR				m ³ /h	DEBİ - CAPACITY (Q)						ÖZELLİK
		HP	kW	V	A		1	2	3,5	4,5	6,3	8,1	
VQDS-750A	1 1/4"	1	0,75	220	4,8	Hm (mSS)	9	8,5	7,5	7	5,6	4	TEMİZ SUDA KULLANIMA UYGUN, SIFIR KOTTAN EMİŞ GÖVDE: AISI304, Çark: PPO, Şamandıralı



VQDS

TİP TYPE	ÇIKIŞ AĞIZI OUTLET	MOTOR				m ³ /h	DEBİ - CAPACITY (Q)						ÖZELLİK
		HP	kW	V	A		0	3	6	9	12	15	
VQDX6-28/2-1.1A	2"	1,5	1,1	220	5,5	Hm(mSS)	32	31	30	25	19	8	MOTOR GÖVDESİ & MİL: AISİ304 Paslanmaz Çelik, POMPA GÖVDESİ & ÇARK: Pik Döküm, Şamandıralı , 12 mt. Kablo ve Fişli
VQDX6-39/3-1.5A	2"	2	1,5	220	9		39	38	35	30	22	11	
VQDX6-50/4-2.2A	2"	3	2,2	220	12		50	48	43	36	26	14	



VQDX

DALDIRMA DERİNLİĞİ (mSS): 8 mSS

DRENAJ POMPALARI (Pis Su)

DRAINAGE PUMPS (Dirty Water)

TİP	ÇIKIŞ AĞIZI OUTLET	MOTOR				m ³ /h	DEBİ - CAPACITY (Q)						ÖZELLİK
		HP	kW	V	A		5	10	15	20	24	40	
VQD5-15-0.75F	2"	1	0,75	220	4,8	Hm (mSS)	15	12	8	4	-	-	PARÇALAYICI AÇIK FANLI PİS SU DRENAJI, GÖVDE&FAN: PİK DÖKÜM, ÇİFT TARAFLI MEKANİK SALMASTRA, Şamandıralı, 10 mt. Kablo ve Fişli
VQD7-15-1.1F	2"	1,5	1,1	220	5,5		17	14	11	5	3		



VQD5



VQD7

DALDIRMA DERİNLİĞİ (mSS): 5 mSS

TİP TYPE	Boyutlar - Dimensions (mm)			Ağırlık Weight Kg.
	Boy-L	Yük-H	En-W	
	Length	Height	Width	
VQDP-550A	240	35	160	4,5
VQDS-750DW	290	370	160	6
VQDX8-22-1.1A	250	490	200	21
VQDS-750A	150	355	150	5,5
VQDX6-28/2-1.1A				22
VQDX6-39/3-1.5A				27
VQDX6-50/4-2.2A				35
VQDX6-32-1.5A	250	520	200	24
VQD5-15-0.75F	245	450	200	20
VQD7-15-1.1F	300	520	190	27

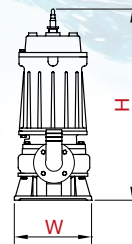
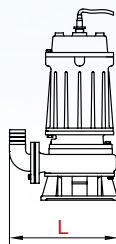

DİK BIÇAKLI DRENAJ POMPALARI (PİS SU)

CUTTING SYSTEM DRAINAGE PUMPS (Dirty water)

CUT SERİSİ

TİP TYPE	ÇIKIŞ AĞIZI OUTLET	MOTOR				m ³ /h	DEBİ - CAPACITY (Q)						ÖZELLİK
		HP	kW	V	A		3	6	9	12	15	18	
VCUT800	2"	1,1	0,8	220	6,5	Hm (mSS)	14	12	11	9	6	3	DİK BIÇAKLI AÇIK FANLI PİS SU DRENAJI, GÖVDE & FAN: PİK DÖKÜM, ÇİFT TARAF MEKANİK SALMASTRA, Şamandıralı, 10 mt. Kablo ve Fişli
VCUT1100	2"	1,5	1,1	220	9		18	16	14	11	8	5	
VCUT1500	2"	2	1,5	220	12		21	19	16	14	11	7	

DALDIRMA DERİNLİĞİ (mSS): 5 mSS
Max. Partikül Çapı: Ø 5 mm



TİP TYPE	Boyutlar - Dimensions (mm)			Ağırlık Weight Kg.
	Boy-L	Yük-H	En-W	
	Length	Height	Width	
VCUT800	310	640	230	28,5
VCUT1100	310	640	230	31
VCUT1500	310	670	230	34

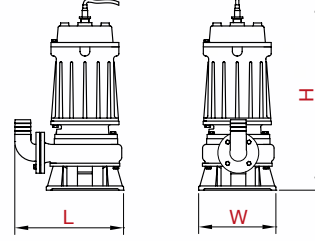

VQK SERİSİ

TİP TYPE	ÇIKIŞ AĞIZI OUTLET	MOTOR				m ³ /h	DEBİ - CAPACITY (Q)						ÖZELLİK
		HP	kW	V	A		9	18	27	36	45	54	
VQK15-7-1.1QG	1¼"	1,5	1,1	380	9	Hm (mSS)	9	6					TRİFAZE, DİK BIÇAKLI AÇIK FANLI PİS SU DRENAJI, GÖVDE & FAN: PİK DÖKÜM, ÇİFT TARAF MEKANİK SALMASTRA, 10 mt. Kablo
VQK30-7-2.2QG	2"	3	2,2	380	4		15	13	10	8			
VQK30-10-3QG	2.5"	4	3	380	6,1		18	16	14	11			
VQK40-10-4QG	3"	5,5	4	380	7,5		20	18	16	14	9		
VQK55-10-5.5QG	3"	7,5	5,5	380	11,5		27	26	23	21	18	13	

*LEDLİ ELEKTRONİK PANO + FLATÖR OPSİYONELDİR.

DALDIRMA DERİNLİĞİ (mSS): 5 mSS
Max. Partikül Çapı: Ø 5 mm

TİP TYPE	Boyutlar - Dimensions (mm)			Ağırlık Weight Kg.
	Boy-L	Yük-H	En-W	
	Length	Height	Width	
VQK15-7-1.1QG	220	480	250	25
VQK30-7-2.2QG	300	550	250	39
VQK30-10-3QG	320	580	270	47
VQK40-10-4QG	330	600	290	56
VQK55-10-5.5QG	340	650	300	66

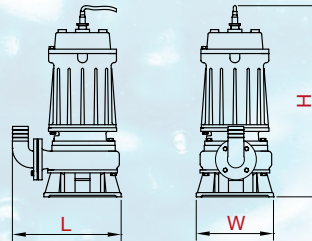

4SD

4" DALGIÇ POMPALAR

4" SUBMERSIBLE PUMPS

(Dış Çap: Ø96 mm)

TİP TYPE	MOTOR				ÇIKIŞ Outlet	m ³ /h	DEBİ(Q)-CAPACITY							BOY-L		KG	
	HP	V		A			0.5	1.2	2.4	3	3.6	4.2	5	Mnf	Trf		
		Mono	Tri	Mono										Tri	mm		
4SD 4/8	0.75	220	380	4.5	2.5	1 1/4"	H(m)	60	56	50	44	36	29	14	810	795	12
4SD 4/10	1	220	380	5.4	2.5			75	70	63	55	46	41	20	930	910	14
4SD 4/14	1.5	220	380	7.5	3.4			105	98	87	77	63	48	25	1050	1010	16
4SD 4/18	2	220	380	11.5	4.4			135	126	112	99	81	60	32	1250	1200	19
4SD 4/24	3	220	380	15	6			180	168	149	134	108	80	43	1500	1425	24
4SD 4/30	4	-	380	-	8.2			225	210	186	167	135	117	52	-	1690	25
4SD 4/40	5.5	-	380	-	10			300	277	246	222	198	170	68	-	2120	38

4SD SERİSİ TEKNİK ÖZELLİKLERİ

- Motor ve Pompa Kılıfı: AISI 304 Paslanmaz Çelik
- Çıkış Gövdesi: AISI 304 Paslanmaz Çelik (çekvalf donanımlı)
- Emiş Gövdesi: AISI 304 Paslanmaz Çelik
- Mil: AISI 304 Paslanmaz Çelik
- Çarklar: POM (Delrin)
- Difüzörler: PC (Lexan)
- Max. İzin verilebilir kum 25 gr./m³
- Mekanik keçe: Karbon-SiC/TC)
- Süzgeç: AISI 304 Paslanmaz Çelik
- Kaplin: AISI 316 Paslanmaz Çelik
- SIVI SICAKLIĞI: +5 °C ~ +40°C
- Suya dalma derinliği: Max: 40 mt.
- Yağ soğutmalı motor
- İzolasyon sınıfı: B
- Koruma sınıfı: IP68
- Frekans: 50Hz
- Yol verme sayısı saatte: Max 20

TECHNICAL DATA

- Motor and Pump Tube: S/S (AISI 304)
- Outlet section: S/S (AISI 304) (built in check valve)
- Suction section: Stainless steel Pump
- Shaft: AISI 304 stainless steel
- Motor shaft gear: AISI 316 stainless steel
- Impellers: POM (Delrin)
- Diffuser: PC(Lexan)
- Max. Sand amount 25 gr./m³
- Mechanical seal:(Carbon-SiC/TC)
- Strainer: AISI 304 Stainless steel
- Coupling: AISI 316 stainless steel
- Max liquid temp.: +5 °C ~ +40°C
- Immersion depth: Max 40 mt
- Oil cooling motor
- Insulation Class: B
- Protection Class: IP68
- Frequency: 50Hz
- Starts per/h: 20 times max

KULLANIM ALANLARI

- Yer altı sularının çıkartılması
- Derin kuyular
- Tarımsal sulama
- Endüstriyel tesisler
- Binalar
- Evler

APPLICATIONS

- Lifting of ground waters
- Deep wells
- Irrigation
- Industry
- Constructions
- Residences



4" DALGIÇ MOTORLAR

4" SUBMERSIBLE MOTORS

HP	kW	V	A	Hz	Devir	KOND.	ÇAP	BOY	KG
					d/d	µF	mm	mm	
0.75	0.55	220	4.5	50	2900	25	96	360	9
1	0.75		5.4			35		401	13
1.5	1.1		7.5			45		416	14
2	1.5		11.5			55		416	14
3	2.2		15.0			70		456	16
1	0.75		380			2.5		2900	-
1.5	1.1	3.4		-	416	14			
2	1.5	4.4		-	416	14			
3	2.2	6.0		-	456	16			
4	3	8.2		-	496	17			
5.5	4	10.0		-	576	21			
7.5	5.5	14.0		-	676	26			
10	7.5	18.0		-	776	31			



Hidroforlar Booster Systems



PAKET HİDROFORLAR

PACKAGED BOOSTER SETS

MİNİ HİDROFORLAR (Sürtme Çarklı-Preferikal Pompalı)

BOOSTER SETS WITH PERIPHERAL PUMPS

TİP TYPE	KAT	DAİRE	POMPA TİPİ	HP	GİRİŞ ÇIKIŞ AĞZI	TANK LT.	İRTİFA	DEBİ
							HM	m ³ /H
QB-60 MİNİ HİD. / 24	3	1	QB 60	½	1" x 1"	24	20-30	1.5 - 1
QB-80 HİD. / 24	5	3	QB 80	1			35-50	2.5 - 1.5

*DİJİTAL ELEKTRONİK PANO + FLATÖR OPSİYONELDİR. (128 USD)

Not: Tank çalışma basıncı: Azami 8 bar



JET POMPALI HİDROFORLAR

BOOSTER SETS WITH JET PUMPS

TİP TYPE	KAT	DAİRE	POMPA TİPİ	HP	GİRİŞ ÇIKIŞ AĞZI	TANK LT.	İRTİFA	DEBİ
							HM	m ³ /H
JET60B HİD./24	4	6	JET 60B	0,5	1" x 1"	24	25-35	2 - 1,5
JET 100 B HİD./24*	7	6	JET 100 B	1			25-45	3 - 2
SJET 100C HİD/24* (ÇELİK JET)	7	6	SJET 100A	1			25-42	3 - 2
JET 180 HİD. / 24*	9	10	JET 180 A	1,5	1¼"-1"	50	35-57	4 - 3
JET 180 HİD. / 50*	9	12	JET 180 A	1,5			35-57	4 - 3



HİDROKİTLİ HİDROFORLAR

BOOSTER SETS WITH ELECTRONIC PRESSURE CONTROLLER

TİP TYPE	KAT	DAİRE	POMPA TİPİ	HP	GİRİŞ ÇIKIŞ AĞZI	HİDRO KİT	İRTİFA	DEBİ
							HM	m ³ /H
QB-60 /HİDRO KİT.	3	1	QB 60	½	1" x 1"	PC - 13A	20-30	1.5 - 1
QB-80 /HİDRO KİT.	5	3	QB 80	1			35-50	2.5 - 1.5
SJET 100C /HİDRO KİT (ÇELİK JET)	5	6	SJET 100A	1			25-40	3 - 2
JET 100 B /HİDRO KİT	5	6	JET 100 B	1			25-40	3 - 2



TİP TYPE	Boyutlar - Dimensions (mm)			Ağırlık
	Boy-L	Yük-H	En-W	Weight
	Length	Height	Width	Kg.
QB-60 HİD. / 24	540	590	330	12
QB-80 HİD. / 24	540	620	320	16
JET60B HİD./24	550	620	320	19,5
JET 100 B HİD./24*	540	620	320	21,5
SJET 100C HİD/24* (ÇELİK JET)	620	690	360	20
JET 180 HİD. / 24*	580	660	330	31,5
JET 180 HİD. / 50*	670	670	370	34

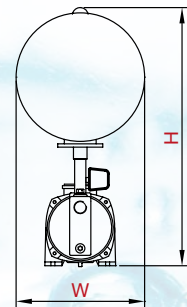
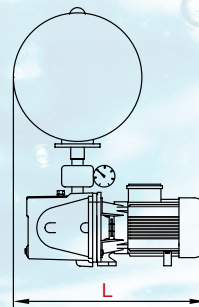

2 KADEMELİ POMPALI HİDROFORLAR

BOOSTER SETS WITH DOUBLE STAGE PUMPS

TİP TYPE	KAT	DAİRE	POMPA TİPİ	HP	GİRİŞ ÇIKIŞ AĞZI	TANK LT.	İRTİFA	DEBİ
							HM	m ³ /H
KS-115 HİD. / 24*	6	6	KS-115	1.5	1" - 1"	24	30 - 40	5 - 2
KS-12 HİD. / 24*	6	8	KS-12	2	1" - 1"		30 - 40	6 - 2
KS-142 HİD. / 24*	6	10	KS-142	2	1¼" - 1"		30 - 40	7 - 3
KS-143 HİD. / 24*	7	12	KS-143	3	1¼" - 1"		35 - 45	8 - 4
KS-115 HİD. / 50*	6	8	KS-115	1.5	1" - 1"	50	30 - 40	5 - 2
KS-12 HİD. / 50*	6	10	KS-12	2	1" - 1"		30 - 40	6 - 2
KS-142 HİD. / 50*	6	12	KS-142	2	1¼" - 1"		30 - 40	7 - 3
KS-143 HİD. / 50*	7	12	KS-143	3	1¼" - 1"		35 - 45	8 - 4
KS-142 HİD. / 80*	6	12	KS-142	2	1¼" - 1"	80	30 - 40	7 - 3
KS-143 HİD. / 80*	7	14	KS-143	3	1¼" - 1"		35 - 45	8 - 4
KS-143 HİD. / 100*	7	14	KS-143	3	1¼" - 1"	100	35-45	8 - 4
KS-155 HİD. / 100*	8	25	KS-155	5,5	1.5" - 1¼"		40 - 55	15 - 4

TİP TYPE	KAT	DAİRE	POMPA TİPİ	HP	GİRİŞ ÇIKIŞ AĞZI	TANK LT.	İRTİFA	DEBİ
							HM	m ³ /H
2HCP25/140 HİD. / 24*	6	6	2TCP25/140	1,5	1¼" - 1"	24	30 - 40	5 - 2
2HCP-160B HİD./24*	6	10	2HCP-160B	2	1.5" - 1"		30-40	7 - 3
2HCP-160B HİD. / 50*	6	12	2HCP-160B	2	1.5" - 1"	50	30-40	7 - 3
2HCP-160B HİD. / 80*	6	12	2HCP-160B	2	1.5" - 1"	80	30-40	7 - 3
2HCP-180 HİD./80*	7	14	2HCP-180	3	1.5" - 1¼"		35-45	8 - 4
2HCP-180 HİD. / 100*	7	14	2HCP-180	3	1.5" - 1¼"	100	35-45	8 - 4
2HCP-200 HİD. / 100*	8	25	2HCP-200	4	1.5" - 1¼"		40-55	15 - 4

*DİJİTAL ELEKTRONİK PANO + FLATÖR OPSİYONELDİR.

Not: Tank çalışma basıncı: Azami 8 bar



TİP TYPE	Boyutlar - Dimensions (mm)			Ağırlık Weight Kg.
	Boy-L	Yük-H	En-W	
	Length	Height	Width	
2HCP25/140 HİD. / 24*	540	690	360	27
KS-115 HİD. / 24*	540	690	360	32
KS-12 HİD. / 24*	550	750	360	34
KS-142 HİD. / 24*	550	750	360	40
KS-143 HİD. / 24*	500	750	360	40
2TCP25/160 HİD. / 50*	640	740	370	39
KS-115 HİD. / 50*	640	710	370	38
KS-12 HİD. / 50*	640	710	370	40
KS-142 HİD. / 50*	640	710	370	44
KS-143 HİD. / 50*	640	710	370	44
2TCP25/160 HİD. / 80*	870	820	460	46
KS-142 HİD. / 80*	870	790	460	50
KS-143 HİD. / 80*	870	790	460	50
KS-143 HİD./100*	940	900	460	52
KS-155 HİD. / 100*	940	900	460	58

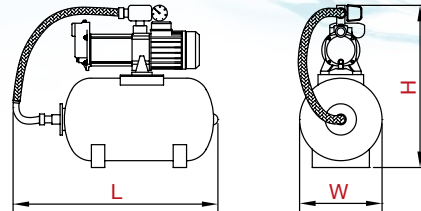

YATAY KADEMELİ POMPALI HİDROFORLAR

BOOSTER SETS WITH MULTI-STAGE PUMPS

TİP TYPE	KAT	DAİRE	POMPA TİPİ	HP	GİRİŞ ÇIKIŞ AĞZI	TANK LT.	İRTİFA	DEBİ
							HM	m ³ /H
BM2-9x5 HİD./50	7	20	BM2-9x5	1,5	1" - 1"	50	16 - 58	1 - 4
BM2-9x6 HİD./50	8	20	BM2-9x6	1,5	1" - 1"		22 - 67	1 - 4
BM4-9x5 HİD./50	8	30	BM4-9x5	2	1" - 1"		27 - 66	1 - 6
BM4-9x6 HİD./50	11	30	BM4-9x6	2	1" - 1"		34 - 77	1 - 6
BM2-9x5 HİD./80	7	20	BM2-9x5	1,5	1" - 1"	80	16 - 58	1 - 4
BM2-9x6 HİD./80	8	20	BM2-9x6	1,5	1" - 1"		22 - 67	1 - 4
BM4-9x5 HİD./80	8	30	BM4-9x5	2	1" - 1"		27 - 66	1 - 6
BM4-9x6 HİD./80	11	30	BM4-9x6	2	1" - 1"		34 - 77	1 - 6
BM4-9x5 HİD./100	8	30	BM4-9x5	2	1" - 1"	100	27 - 66	1 - 6
BM4-9x6 HİD./100	11	30	BM4-9x6	2	1" - 1"		34 - 77	1 - 6

*Dijital Elektronik Pano + Flatör Opsiyoneldir.

Not: Tank çalışma basıncı: Azami 10 bar

TİP TYPE	Boyutlar - Dimensions (mm)			Ağırlık Weight Kg.
	Boy-L	Yük-H	En-W	
	Length	Height	Width	
BM2-9x5 HİD./50				
BM2-9x6 HİD./50	640	72	350	24
BM4-9x5 HİD./50				31
BM4-9x6 HİD./50				
BM2-9x5 HİD./80				29
BM2-9x6 HİD./80				
BM4-9x5 HİD./80				36
BM4-9x6 HİD./80	740	880	410	
BM4-9x5 HİD./100				
BM4-9x6 HİD./100				37

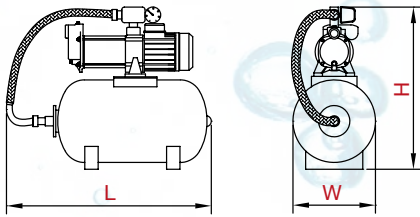

YATAY KADEMELİ ÇELİK (AISI 304) POMPALI HİDROFORLAR

BOOSTER SETS WITH MULTI-STAGE S/S (AISI 304) PUMPS

TİP TYPE	KAT	DAİRE	POMPA TİPİ	HP	GİRİŞ ÇIKIŞ AĞZI	TANK LT.	İRTİFA	DEBİ
							HM	m ³ /H
CMI4-5 HİD./50	7	16	CMI4-5	1	1¼" - 1"	50	23 - 46	6 - 2
CMI4-7 HİD./50	9	16	CMI4-7T	2	1¼" - 1"		38 - 64	6 - 2
CMI8-30 HİD./50	6	32	CMI8-30T	2,5	1,5" - 1,5"		32 - 54	8 - 4
CMI8-40 HİD./50	10	32	CMI8-40T	3	1,5" - 1,5"		43 - 67	8 - 4
CMI8-30 HİD./80	6	32	CMI8-30T	2,5	1,5" - 1,5"	80	32 - 54	8 - 4
CMI8-40 HİD./80	10	32	CMI8-40T	3	1,5" - 1,5"		43 - 67	8 - 4
CMI10-5 HİD./80	13	40	CMI10-5T	4	1,5" - 1,5"	100	63 - 76	10 - 4
CMI8-30 HİD./100	6	32	CMI8-30T	2,5	1,5" - 1,5"		32 - 54	8 - 4
CMI8-40 HİD./100	10	32	CMI8-40T	3	1,5" - 1,5"		43 - 67	8 - 4
CMI10-5 HİD./100	13	40	CMI10-5T	4	1,5" - 1,5"		63 - 76	10 - 4

*Dijital ELEKTRONİK PANO + FLATÖR OPSİYONELDİR.

Not: Tank çalışma basıncı: Azami 10 bar

TİP TYPE	Boyutlar - Dimensions (mm)			Ağırlık Weight Kg.
	Boy-L	Yük-H	En-W	
	Length	Height	Width	
CMI4-7 HİD./50				
CMI8-30 HİD./50				
CMI8-40 HİD./50				
CMI8-30 HİD./80				
CMI8-40 HİD./80				
CMI10-5 HİD./80				
CMI8-30 HİD./100				
CMI8-40 HİD./100				
CMI10-5 HİD./100				

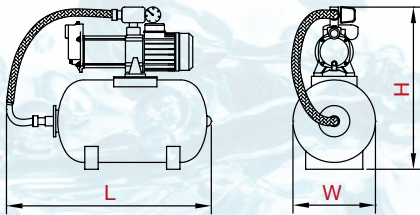

HMC

PAKET HİDROFORLAR (Tank ve Bağlantı Hortumu Hariçtir)

PACKAGED BOOSTER SETS (Excluding pressure tank and flexible hose)

BİR POMPALI HİDROFORLAR / SINGLE-PUMP BOOSTER SETS

TİP TYPE	MOTOR	POMPA MODELİ	KADEME STAGE	KOLLEKTÖR	m ³ /h	DEBİ (Q) - CAPACITY					
	HP			Çıkış Outlet		1	2	3	5	7	8
HMC90x1 HİD.	2,2	HMC90-8SV	8	1"×1"	Hm (mSS)	93	86	77	49		
HMC145x1 HİD.	3,3	HMC145-8SV	8	1 ¼"×1"	Hm (mSS)	103	100	96	80	52	36
HMC10x1 HİD.	5	HMC10-VE	10	1 ¼"×1 ¼"	Hm (mSS)	132	128	118	96	65	45

TAM KORUMALI ELEKTRONİK LCD EKРАНLI PANO FARKI: Mavi LCD Ekran, 0.37 - 7.5 kW arası kullanım imkanı, Moment kontrol ile Susuz çalışmaya karşı Flatör ve SSR kulanmadan koruma, Fazlar arası gerilim gösterimi, Akım değerleri gösterimi, Gerilim koruma (Alt - Üst Gerilim değerleri ayarlama), Akım değerleri ayarlama, Otomatik / Manuel çalışma seçimi, Pompa çalışma zamanını ekranda görebilme, Arıza durumunda kendini otomatik resetleme, son 20 arıza bilgisi, Arıza durumunda sesli buzzer ve Röle kontağı ile bildirme. Otomatik Sulama özelliği Türkçe ve İngilizce Dil seçeneği.



İKİ POMPALI HİDROFORLAR / TWO-PUMP BOOSTER SETS

TİP TYPE	MOTOR	POMPA MODELİ	KADEME STAGE	KOLLEKTÖR	m ³ /h	DEBİ (Q) - CAPACITY					
	HP			GirişÇıkış InletxOutlet		2	4	6	10	14	16
HMC90x2 HİD.	2,2	HMC90-8SV	8	1½" X 1¼"	Hm (mSS)	93	86	77	49		
HMC145x2 HİD.	3,3	HMC145-8SV	8		Hm (mSS)	103	100	96	80	52	36
HMC10x2 HİD.	5	HMC10-VE	10		Hm (mSS)	132	128	118	96	65	45

TAM KORUMALI ELEKTRONİK LCD EKРАНLI PANO FARKI: Mavi LCD Ekran, 0.37 - 7.5 kW arası kullanım imkanı, Moment kontrol ile Susuz çalışmaya karşı Flatör ve SSR kulanmadan koruma, Fazlar arası gerilim gösterimi, Akım değerleri gösterimi, Gerilim koruma (Alt - Üst Gerilim değerleri ayarlama), Akım değerleri ayarlama, Otomatik / Manuel çalışma seçimi, Pompa çalışma zamanını ekranda görebilme, Arıza durumunda kendini otomatik resetleme, son 20 arıza bilgisi, Arıza durumunda sesli buzzer ve Röle kontağı ile bildirme. Otomatik Sulama özelliği Türkçe ve İngilizce Dil seçeneği.



ÜÇ POMPALI HİDROFORLAR / THREE-PUMP BOOSTER SETS

TİP TYPE	MOTOR	POMPA MODELİ	KADEME STAGE	KOLLEKTÖR	m ³ /h	DEBİ (Q) - CAPACITY					
	HP			GirişÇıkış InletxOutlet		3	6	9	15	21	24
HMC90x3 HİD.	2,2	HMC90-8SV	8	2" X 2"	Hm (mSS)	93	86	77	49		
HMC145x3 HİD.	3,3	HMC145-8SV	8		Hm (mSS)	103	100	96	80	52	36
HMC10x3 HİD.	5	HMC10-VE	10		Hm (mSS)	132	128	118	96	65	45

TAM KORUMALI ELEKTRONİK LCD EKРАНLI PANO FARKI: Mavi LCD Ekran, 0.37 - 7.5 kW arası kullanım imkanı, Moment kontrol ile Susuz çalışmaya karşı Flatör ve SSR kulanmadan koruma, Fazlar arası gerilim gösterimi, Akım değerleri gösterimi, Gerilim koruma (Alt - Üst Gerilim değerleri ayarlama), Akım değerleri ayarlama, Otomatik / Manuel çalışma seçimi, Pompa çalışma zamanını ekranda görebilme, Arıza durumunda kendini otomatik resetleme, son 20 arıza bilgisi, Arıza durumunda sesli buzzer ve Röle kontağı ile bildirme. Otomatik Sulama özelliği Türkçe ve İngilizce Dil seçeneği.



TEKNİK ÖZELLİKLER

Pompa:

- Pompa Gövdesi: GG-22 Pik
- Kademe Gömleği: AISI 304 Çelik
- Çark: AISI304 Paslanmaz çelik
- Pompa Mili: AISI 304 Çelik
- Mekanik Salmastra sızdırmazlık (Karbon/Seramik/NBR)
- Çok Sesiz Çalışma, düşük sarfiyat.
- Sıvı sıcaklığı: +5 °C ~ +60 °C
- Çek-Valf ve Vana donanımı
- Şase: Çelik Sac (Titreşim önleyici kauçuk ayaklı)
- Susuz Çalışma Önleyici Seviye Flatörü
- Emiş ve Basış Kollektörleri dahil.
- Monometre ve Basınç Şalterli.
- Çek-Valf: Yaylı, sessiz
- Vana: Küresel (Bir Pompalı Hidroforlarda opsiyonel)

Pano:

- Faz Gerilim Koruma (Alt - Üst Değer Girebilme)
- Motor Akım Koruma (Alt - Üst Değer Girebilme)
- Çalışma Mod Seçimi
- Uyarı Ledleri
- Otomatik Resetleme

Opsiyonel Tam Korumalı Pano:

- Motor Tanıma Modu
- Cihazda Oluşan Son 20 Arıza Kaydı
- Sulama Modu
- Nötrsüz Çalışma (Gemilerde Kullanım İmkani)

Not:

- Emiş Yapan Hidroforlarda Emiş Kollektörü Kullanılmaz. Her Pompaaya ayrı emiş borusu ve dip klapesi olmalıdır.
- Motorlarınızın sorunsuz çalışabilmesi ancak Motor Koruma Sistemli Panoların kullanımı ile mümkündür.

KULLANIM ALANLARI

- Apartmanlar, siteler
- Okul, iş ve alışveriş merkezleri
- Sosyal tesisler
- Yangın söndürme sistemleri
- Su dağıtım istasyonları

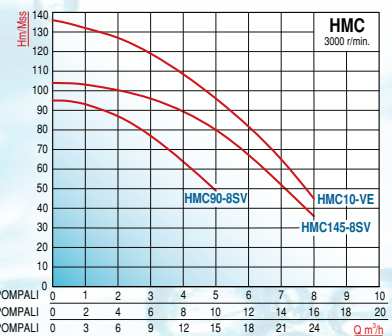

PVM

BİR POMPALI PAKET HİDROFORLAR (Tank ve Bağlantı Hortumu Hariçtir)

SINGLE-PUMP PACKAGED BOOSTER SETS (Excluding pressure tank and flexible hose)

TİP TYPE	KAT	DARİE SAYISI	MOTOR HP	POMPA MODELI	KADEME STAGE	KOLLEKTÖR		m ³ /h	DEBİ (Q) - CAPACITY					
						Giriş Inlet	Çıkış Outlet		1	3	7	12	18	20
PVM4-4x1 HİD.	6	12	1.5	VM4-4	4	1"	1"	Hm (mss)	53	50	40	20		
PVM2-7x1 HİD.	10	12	1.5	VM2-7	7	1"	1"		80	65	35			
PVM2-9x1 HİD.	15	14	2	VM2-9	9	1"	1"		108	87	45			
PVM4-6x1 HİD.	10	24	2	VM4-6	6	1"	1"		80	76	63	35		
PVM4-8x1 HİD.	15	24	3	VM4-8	8	1"	1"		99	97	82	45		
PVM12-6x1 HİD.	8	45	4	VM12-6	6	1.5"	1.5"		66	65	60	52	40	25
PVM12-8x1 HİD.	12	45	6.3	VM12-8	8	1.5"	1.5"		87	85	77	66	42	30
PVM14-4x1 HİD.	11	33	4	VM14-4	4	1.5"	1.5"		70	69	67	61	46	29
PVM14-5x1 HİD.	16	36	5.5	VM14-5	5	1.5"	1.5"		91	90	81	69	52	34
PVM14-7x1 HİD.	22	40	7.5	VM14-7	7	1.5"	1.5"		122	121	108	90	67	42

TAM KORUMALI ELEKTRONİK LCD EKSPANLI PANO FARKI: Mavi LCD Ekran, 0.37 - 7.5 kW arası kullanım imkanı, Moment kontrol ile Susuz çalışmaya karşı Flatör ve SSR kullanmadan koruma, Fazlar arası gerilim gösterimi, Akım değerleri gösterimi, Gerilim koruma (Alt - Üst Gerilim değerleri ayarlama), Akım değerleri ayarlama, Otomatik / Manuel çalışma seçimi, Pompa çalışma zamanını ekranda görebilme, Arıza durumunda kendini otomatik resetleme, son 20 arıza bilgisi, Arıza durumunda sesli buzzer ve Röle kontağı ile bildirme. Türkçe ve İngilizce Dil seçeneği.



TEKNİK ÖZELLİKLER

Pompa:

- Pompa Gövdesi: GG-25 Pük
- Kademe Gömleđi: AISI 304 Çelik
- Çark, Difüzör: Noryl (PPO)
- Pompa Mili: AISI 304 Çelik
- Mekanik Salmastra sızdırmazlık (Karbon/Seramik/Viton)
- Çok Sesiz çalışma, düşük sarfiyat.
- Sıvı sıcaklığı: +5 °C ~ +60 °C
- Çek-Valf ve Vana donanımı
- Şase: Çelik Sac (Titreşim önleyici kauçuk ayaklı)
- Susuz çalışma önleyici Seviye Flatörü
- Emiş ve Basış Kollektörleri dahil.
- Monometre ve Basış Şalteri.
- Çek-Valf: Yaylı, sessiz
- Vana: Küresel (Bir Pompalı Hidroforlarda opsiyonel)

KULLANIM ALANLARI

- Apartmanlar, siteler
- Okul, iş ve alışveriş merkezleri
- Sosyal tesisler
- Yangın söndürme sistemleri
- Su dağıtım istasyonları

Pano:

- Faz Gerilim Koruma (Alt - Üst Deđer Girebilme)
- Motor Akım Koruma (Alt - Üst Deđer Girebilme)
- Çalışma Mod Seçimi
- Uyarı Ledleri
- Otomatik Resetleme

Opsiyonel Tam Korumalı Pano:

- Motor Tanıma Modu
- Cihazda Oluşan Son 20 Arıza Kaydı
- Sulama Modu
- Nötrüz Çalışma (Gemilerde Kullanım imkanı)

Not:

- Emiş Yapan Hidroforlarda Emiş Kollektörü Kullanılmaz. Her Pompaya ayrı emiş borusu ve dip klapesi olmalıdır.
- Motorlarınızın sorunsuz çalışabilmesi ancak Motor Koruma Sistemli Panoların kullanımı ile mümkündür.

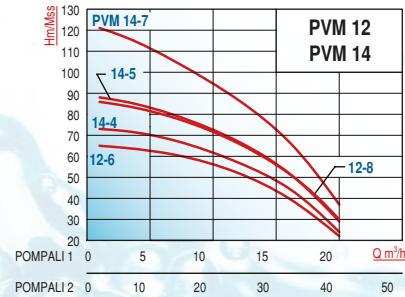
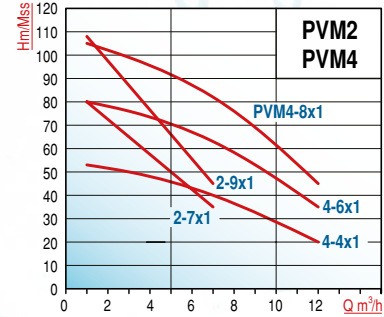

TİP TYPE	Boyutlar - Dimensions (mm)			Ağırlık Weight
	En-W	Yük-H	Boy-L	
	Width	Height	Length	Kg.
PVM2-7x1 HİD.	340	598	390	27
PVM2-9x1 HİD.	340	646	390	32
PVM4-4x1 HİD.	340	490	390	26
PVM4-6x1 HİD.	340	574	390	28
PVM4-8x1 HİD.	340	622	390	31
PVM12-6x1 HİD.	340	700	390	36
PVM12-8x1 HİD.	340	820	390	39
PVM14-4x1 HİD.	340	630	480	42
PVM14-5x1 HİD.	340	661	480	44
PVM14-7x1 HİD.	340	723	480	50

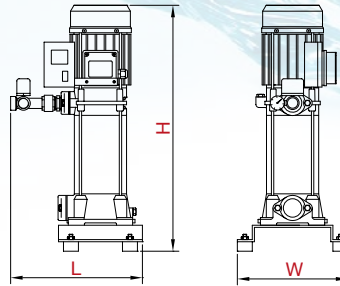

PVM

İKİ POMPALI PAKET HİDROFORLAR (Tank ve Bağlantı Hortumu Hariçtir)

TWO-PUMP PACKAGED BOOSTER SETS (Excluding pressure tank and flexible hose)

TİP TYPE	KAT	DARİE SAYISI	MOT. HP	POMPA MODELİ	KADEME STAGE	KOLLEKTÖR		m ³ /h	DEBİ (Q) - CAPACITY							
						Giriş Inlet	Çıkış Outlet		2	6	14	24	36	40		
PVM4-4x2 HİD.	6	24	1.5	VM4-4	4	2"	1½"	Hm (mSS)	53	50	40	20				
PVM2-7x2 HİD.	10	24	1.5	VM2-7	7	1½"	1¼"		80	65	35					
PVM2-9x2 HİD.	15	28	2	VM2-9	9	1½"	1¼"		108	87	45					
PVM4-6x2 HİD.	10	48	2	VM4-6	6	2"	1½"		80	76	63	35				
PVM4-8x2 HİD.	15	48	3	VM4-8	8	2"	1½"		99	97	82	45				
PVM12-6x2 HİD.	8	90	4	VM12-6	6	2,5"	2,5"		66	65	60	52	40	25		
PVM12-8x2 HİD.	12	90	6,3	VM12-8	8	2,5"	2,5"		87	85	77	66	42	30		
PVM14-4x2 HİD.	11	66	4	VM14-4	4	2,5"	2,5"		70	69	67	61	46	29		
PVM14-5x2 HİD.	16	80	5.5	VM14-5	5	2,5"	2,5"		91	90	81	69	52	34		
PVM14-7x2 HİD.	22	80	7.5	VM14-7	7	2,5"	2,5"		122	121	108	90	67	42		

TAM KORUMALI ELEKTRONİK LCD EKRANLI PANO FARKI: Mavi LCD Ekran, 0.37 - 7.5 kW arası kullanım imkanı, Moment kontrol ile Susuz çalışmaya karşı Flatör ve SSR kulanmadan koruma, Fazlar arası gerilim gösterimi, Akım değerleri gösterimi, Gerilim koruma (Alt - Üst Gerilim değerleri ayarlama), Akım değerleri ayarlama, Otomatik / Manuel çalışma seçimi, Pompa çalışma zamanını ekranda görebilme, Arıza durumunda kendini otomatik resetleme, son 20 arıza bilgisi, Arıza durumunda sesli buzzer ve Röle kontağı ile bildirme. Türkçe ve İngilizce Dil seçeneği.



TEKNİK ÖZELLİKLER

Pompa:

- Pompa Gövdesi: GG-25 Pik
- Kademe Gömleği: AISI 304 Çelik
- Çark, Difüzör: Noryl (PPO)
- Pompa Mili: AISI 304 Çelik
- Mekanik Salmastra sızdırmazlık (Karbon/Seramik/Viton)
- Çok Sesiz çalışma, düşük sarfiyat.
- Sıvı sıcaklığı: +5 °C ~ +60 °C
- Çek-Valf ve Vana donanımı
- Şase: Çelik Sac (Titreşim önleyici kauçuk ayaklı)
- Susuz Çalışma Önleyici Seviye Flatörü
- Emiş ve Basış Kollektörleri dahil.
- Monometre ve Basınç Şalterli.
- Çek-Valf: Yaylı, sessiz
- Vana: Küresel (Bir Pompalı Hidroforlarda opsiyonel)

Pano:

- Faz Gerilim Koruma (Alt - Üst Değer Girebilme)
- Motor Akım Koruma (Alt - Üst Değer Girebilme)
- Çalışma Mod Seçimi
- Uyarı Ledleri
- Otomatik Resetleme

Opsiyonel: LCD Pano (Hassas Ayarlı):

- LCD Göstergeli Ekran
- Hassas Ayar Butonları
- Voltmetre & Ampermetre & Pompa Çalışma Süreleri, Koruma Gecikme Süreleri ve Tolerans Yüzdeleri (Dijital Göstergeli)
- Faz Gerilim Koruma özelliği,
- Motor Koruma (Ampermetrik)
- Yüksek Akım ve Gerilime Karşı Hassas Motor Koruma,
- Düşük Akım ve Gerilime Karşı Hassas Koruma,
- Süreli ve Rotasyonlu (Sıralı) Çalıştırma Yöntemi ile Eş Yaşlandırma
- Şalt Sayısı / Saat Ayarı
- Kalkışta Yüzdesel Demeraj Tolerans Ayarı
- Akım ve Koruma Gecikme Süresi ayar özelliği
- Sistem İkaz Ledleri (Susuz - Voltaj - Faz - Çalışma-Arıza)
- Susuz çalışmaya karşı Akım Kontrollü ve Flatörlü koruma,
- Her Pompa için Otomatik - Manuel Test Butonu,
- Haftalık Programlı Kendini Test Özelliği (Opsiyonel)

Not:

- Emiş Yapan Hidroforlarda Emiş Kollektörü Kullanılmaz. Her Pompaya ayrı emiş borusu ve dip klapesi olmalıdır.
- Motorlarınızın sorunsuz çalışabilmesi ancak Motor Koruma Sistemli Panoların kullanımı ile mümkündür.

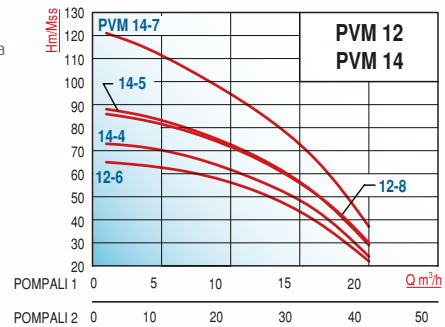
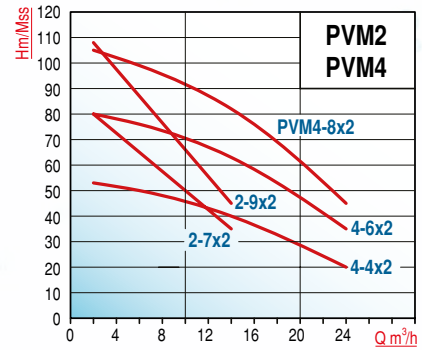

KULLANIM ALANLARI

- Apartmanlar, siteler
- Okul, iş ve alışveriş merkezleri
- Sosyal tesisler
- Yangın söndürme sistemleri
- Su dağıtım istasyonları

TİP TYPE	Boyutlar - Dimensions (mm)			Ağırlık Weight Kg.
	EN-W	Yük-H	Boy-L	
	Width	Height	Length	
PVM2-7x2 HİD.	610	973	440	66
PVM2-9x2 HİD.	610	1021	440	76
PVM4-4x2 HİD.	610	865	440	64
PVM4-6x2 HİD.	610	949	440	68
PVM4-8x2 HİD.	610	997	440	74
PVM12-6x2 HİD.	610	1075	440	84
PVM12-8x1 HİD.	610	1195	440	90
PVM14-4x2 HİD.	610	987	440	95
PVM14-5x2 HİD.	610	1018	440	100
PVM14-7x2 HİD.	610	1084	440	112

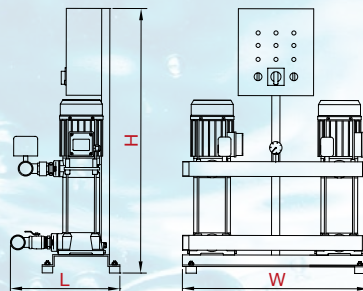

PVM

ÜÇ POMPALI PAKET HİDROFORLAR (Tank ve Bağlantı Hortumu Hariçtir)

THREE-PUMP PACKAGED BOOSTER SETS (Excluding pressure tank and flexible hose)

TİP TYPE	KAT	DARİE SAYISI	MOTOR HP	POMPA MODELİ	KADEME STAGE	KOLLEKTÖR		m ³ /h	DEBİ (Q) - CAPACITY					
						Giriş Inlet	Çıkış Outlet		3	9	21	36	54	60
PVM4-4x3 HİD.	6	36	1.5	VM14-4	4	3"	2.5"	Hm (mSS)	53	50	40	20		
PVM2-7x3 HİD.	10	36	1.5	VM2-7	7	3"	2.5"		80	65	35			
PVM2-9x3 HİD.	15	42	2	VM2-9	9	3"	2.5"		108	87	45			
PVM4-6x3 HİD.	10	72	2	VM4-6	6	3"	2.5"		80	76	63	35		
PVM4-8x3 HİD.	15	72	3	VM4-8	8	3"	2.5"		99	97	82	45		
PVM12-6x3 HİD.	8	135	4	VM12-6	6	3"	3"		66	65	60	52	40	25
PVM12-8x3 HİD.	12	135	6.3	VM12-8	8	3"	3"		87	85	77	66	42	30
PVM14-4x3 HİD.	11	100	4	VM14-4	4	3"	3"		70	69	67	61	46	29
PVM14-5x3 HİD.	16	120	5.5	VM14-5	5	3"	3"		91	90	81	69	52	34
PVM14-7x3 HİD.	22	120	7.5	VM14-7	7	3"	3"		122	121	108	90	67	42

TAM KORUMALI ELEKTRONİK LCD EKRANLI PANO FARKI: Mavi LCD Ekran, 0.37 - 7.5 kW arası kullanım imkanı, Moment kontrol ile Susuz çalışmaya karşı Flatör ve SSR kullanmadan koruma, Fazlar arası gerilim gösterimi, Akım değerleri gösterimi, Gerilim koruma (Alt - Üst Gerilim değerleri ayarlama), Akım değerleri ayarlama, Otomatik / Manuel çalışma seçimi, Pompa çalışmaz zamanı mekranda görülebile, Arıza durumunda kendini otomatik resetleme, son 20 arıza bilgisi, Arıza durumunda sesli buzzer ve Röle kontağı ile bildirme. Türkçe ve İngilizce Dil seçeneği.

TEKNİK ÖZELLİKLER

Pompa:

- Pompa Gövdesi: GG-25 Pisk
- Kademe Gömleği: AISI 304 Çelik
- Çark, Difüzör: Noryl (PPO)
- Pompa Mili: AISI 304 Çelik
- Mekanik Salmastra sızdırmazlık (Karbon/Seramik/Viton)
- Çok Sesiz çalışma, düşük sarfiyat.
- Sıvı sıcaklığı: +5 °C ~ +60 °C
- Çek-Valf ve Vana donanımı
- Şase: Çelik Sac (Titreşim önleyici kauçuk ayaklı)
- Susuz Çalışma Önleyici Seviye Flatörü
- Emiş ve Basış Kollektörleri dahil.
- Monometre ve Basınç Şalterli.
- Çek-Valf: Yaylı, sessiz
- Vana: Küresel (Bir Pompalı Hidroforlarda opsiyonel)

KULLANIM ALANLARI

- Apartmanlar, siteler
- Okul, iş ve alışveriş merkezleri
- Sosyal tesisler
- Yangın söndürme sistemleri
- Su dağıtım istasyonları

Pano:

- Faz Gerilim Koruma (Alt - Üst Değer Girebilme)
- Motor Akım Koruma (Alt - Üst Değer Girebilme)
- Çalışma Mod Seçimi
- Uyarı Ledleri
- Otomatik Resetleme

Opsiyonel: LCD Pano (Hassas Ayarlı):

- LCD Göstergeli Ekran
- Hassas Ayar Butonları
- Voltmetre & Ampermetre & Pompa Çalışma Süreleri, Koruma Gecikme Süreleri ve Tolerans Yüzdeleri (Dijital Göstergeli)
- Faz Gerilim Koruma özelliği,
- Motor Koruma (Ampermetrik)
- Yüksek Akım ve Gerilime Karşı Hassas Motor Koruma,
- Düşük Akım ve Gerilime Karşı Hassas Koruma,
- Süreli ve Rotasyonlu (Sıralı) Çalıştırma Yöntemi ile Eş Yaşlandırma
- Şalt Sayısı / Saat Ayarı
- Kalkışta Yüzdesel Demeraj Tolerans Ayarı
- Akım ve Koruma Gecikme Süresi ayar özelliği
- Sistem İkaz Ledleri (Susuz - Voltaj - Faz - Çalışma-Arıza)
- Susuz çalışmaya karşı Akım Kontrollü ve Flatörlü koruma,
- Her Pompa için Otomatik - Manuel Test Butonu,
- Haftalık Programlı Kendini Test Özelliği (Opsiyonel)

Not:

- Emiş Yapan Hidroforlarda Emiş Kollektörü Kullanılmaz. Her Pompaya ayrı emiş borusu ve dip klapesi olmalıdır.
- Motorlarınızın sorunsuz çalışabilmesi ancak Motor Koruma Sistemli Panoların kullanımı ile mümkündür.

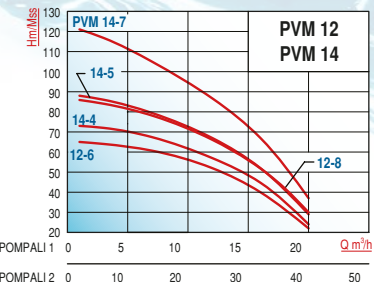
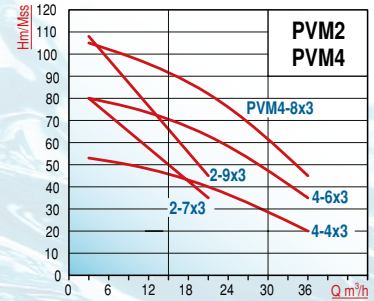

TİP TYPE	Boyutlar - Dimensions (mm)			Ağırlık Weight Kg.
	EN-W Width	Yük-H Height	Boy-L Length	
PVM2-7x3 HİD.	905	973	440	98
PVM2-9x3 HİD.	905	1021	440	113
PVM4-4x3 HİD.	905	865	440	95
PVM4-6x3 HİD.	905	949	440	101
PVM4-8x3 HİD.	905	997	440	110
PVM12-6x3 HİD.	905	1075	440	125
PVM12-8x3 HİD.	905	1195	440	134
PVM14-4x3 HİD.	905	987	440	141
PVM14-5x3 HİD.	905	1018	440	149
PVM14-7x3 HİD.	905	1084	440	167

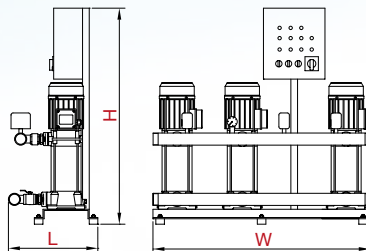

CVL
PASLANMAZ POMPALI PAKET HİDROFORLAR (Tank ve Bağlantı Hortumu Hariçtir)

PACKAGED BOOSTER SETS (Excluding pressure tank and flexible hose)

BİR POMPALI HİDROFORLAR / SINGLE-PUMP BOOSTER SETS

TİP TYPE	MOTOR		KADEME STAGE	KOLLEKTÖR		m ³ /h	DEBİ (Q) - CAPACITY					
	HP	kW		Giriş Inlet	Çıkış Outlet		1	2	2,5	3	3,5	4
CVL3-10x1 HİD.	1	0,75	10				60	55	50	43	36	28
CVL3-12x1 HİD.	1,5	1,1	12	1¼"	1¼"	Hm	72	66	59	52	44	34
CVL3-15x1 HİD.	1,5	1,1	15				90	82	77	69	60	44
CVL3-19x1 HİD.	2	1,5	19				113	104	98	88	77	58
CVL3-29x1 HİD.	3	2,2	29				170	156	147	132	118	93
							2	3	4	5	6,5	8
CVL5-10x1 HİD.	2	1,5	10	1¼"	1¼"	Hm	62	59	55	50	41	30
CVL5-12x1 HİD.	3	2,2	12				75	73	68	62	49	36
CVL5-16x1 HİD.	3	2,2	16				103	100	94	85	69	48
CVL5-20x1 HİD.	4	3	20				129	122	115	105	86	60
CVL5-29x1 HİD.	5,5	4	29				185	177	168	157	132	87
				2	6	8	10	12	14			
CVL10-6x1 HİD.	3	2,2	6	1½"	1½"	Hm	62	58	53	46	38	28
CVL10-7x1 HİD.	4	3	7				73	67	61	54	43	32
CVL10-9x1 HİD.	4	3	9				93	87	81	71	59	42
CVL10-12x1 HİD.	5,5	4	12				123	117	108	95	78	55
CVL10-16x1 HİD.	7,5	5,5	16				163	154	143	125	102	71
				8	12	15	18	20	24			
CVL15-5x1 HİD.	5,5	4	5	2"	2"	Hm	68	61	56	50	45	33
CVL15-7x1 HİD.	7,5	5,5	7				94	88	80	71	64	50
CVL15-9x1 HİD.	10	7,5	9				122	115	106	95	87	66
CVL15-12x1 HİD.	15	11	12				158	150	140	126	116	89
CVL15-14x1 HİD.	15	11	14				183	172	162	145	133	103
				8	12	16	20	24	28			
CVL20-5x1 HİD.	7,5	5,5	5	2"	2"	Hm	68	65	61	55	46	33
CVL20-7x1 HİD.	10	7,5	7				96	92	86	77	65	47
CVL20-10x1 HİD.	15	11	10				137	132	124	112	98	73
CVL20-14x1 HİD.	20	15	14				191	186	176	161	140	110

TEKNİK ÖZELLİKLER
Pompa:

- Pompa Gövdesi: AISI 304 Çelik
- Kademe Gömleği: AISI 304 Çelik
- Çark, Difüzör: AISI 304 Çelik
- Pompa Mili: AISI 304 Çelik
- Mekanik Salmastra sızdırmazlık (Karbon/Seramik/Viton)
- Çok Sesiz çalışma, düşük sarfiyat.
- Sıvı sıcaklığı: +5 °C ~ +90 °C
- Beş Yollu: Princi (Çekvalfli)
- Şase: Çelik Sac (Titreşim önleyici kauçuk ayaklı)
- Susuz Çalışma Önleyici Seviye Flatörü
- Monometre ve Basınç Şalterli.
- Çek-Valf: Yaylı, sessiz
- Vana: Küresel (Bir Pompalı Hidroforlarda opsiyonel)

Pano:

- Motor & Faz Koruma Rölesi,
- Termik Manyetik Şalter,
- Kumanda Sigortası Donanımı
- Sıralı Çalıştırma Sistemi (Eş yaşlandırma)
- Susuz çalışma önleyici
- İkaz Ledleri (Susuz - Voltaj - Faz - Çalışma-Arıza)

KULLANIM ALANLARI

- Apartmanlar, siteler
- Okul, iş ve alışveriş merkezleri
- Sosyal tesisler
- Yangın söndürme sistemleri
- Su dağıtım istasyonları
- Filtre sistemleri (Ters ozmoz)

Not:

- Emiş Yapan Hidroforlarda Emiş Kollektörü Kullanılmaz. Her Pompaya ayrı emiş borusu ve dip klapesi olmalıdır.
- Motorlarınızın sorunsuz çalışabilmesi ancak Motor Koruma Sistemli Panoların kullanımı ile mümkündür.

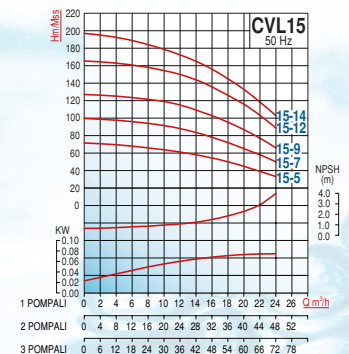
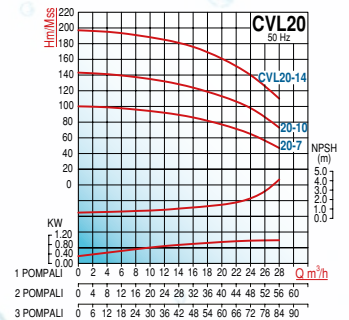
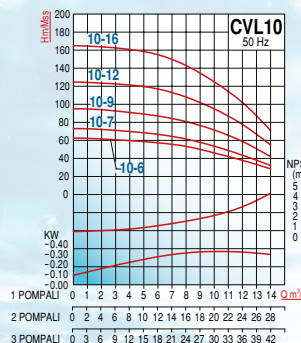
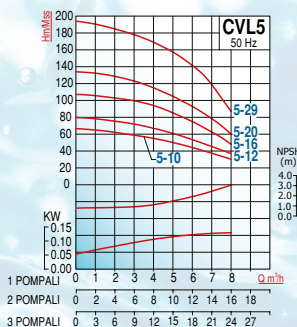
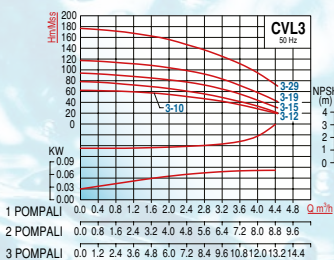

CVL

PASLANMAZ POMPALI PAKET HİDROFORLAR (Tank ve Bağlantı Hortumu Hariçtir)

PACKAGED BOOSTER SETS (Excluding pressure tank and flexible hose)

İKİ POMPALI HİDROFORLAR / TWO-PUMP BOOSTER SETS

TİP TYPE	MOTOR		KADEME STAGE	KOLLEKTÖR		m ³ /h	DEBİ (Q) - CAPACITY					
	HP	kW		Giriş Inlet	Çıkış Outlet		2	4	5	6	7	8
CVL3-10x2 HİD.	1	0,75	10	1,5"	1,5"	HfH	60	55	50	43	36	28
CVL3-12x2 HİD.	1,5	1,1	12				72	66	59	52	44	34
CVL3-15x2 HİD.	1,5	1,1	15				90	82	77	69	60	44
CVL3-19x2 HİD.	2	1,5	19				113	104	98	88	77	58
CVL3-29x2 HİD.	3	2,2	29				170	156	147	132	118	93
							4	6	8	10	13	16
CVL5-10x2 HİD.	2	1,5	10	2"	2"	HfH	62	59	55	50	41	30
CVL5-12x2 HİD.	3	2,2	12				75	73	68	62	49	36
CVL5-16x2 HİD.	3	2,2	16				103	100	94	85	69	48
CVL5-20x2 HİD.	4	3	20				129	122	115	105	86	60
CVL5-29x2 HİD.	5,5	4	29				177	177	168	157	132	87
							4	12	16	20	24	28
CVL10-6x2 HİD.	3	2,2	6	2,5"	2,5"	HfH	62	58	53	46	38	28
CVL10-7x2 HİD.	4	3	7				73	67	61	54	43	32
CVL10-9x2 HİD.	4	3	9				93	87	81	71	59	42
CVL10-12x2 HİD.	5,5	4	12				123	117	108	95	78	55
CVL10-16x2 HİD.	7,5	5,5	16				163	154	143	125	102	71
							16	24	30	36	40	48
CVL15-5x2 HİD.	5,5	4	5	3"	3"	HfH	68	61	56	50	45	33
CVL15-7x2 HİD.	7,5	5,5	7				94	88	80	71	64	50
CVL15-9x2 HİD.	10	7,5	9				122	115	106	95	87	66
CVL15-12x2 HİD.	15	11	12				158	150	140	126	116	89
CVL15-14x2 HİD.	15	11	14				183	172	162	145	133	103
							16	24	32	40	48	56
CVL20-5x2 HİD.	7,5	5,5	5	3"	3"	HfH	68	65	61	55	46	33
CVL20-7x2 HİD.	10	7,5	7				96	92	86	77	65	47
CVL20-10x2 HİD.	15	11	10				137	132	124	112	98	73
CVL20-14x2 HİD.	20	15	14				191	186	176	161	140	110



TEKNİK ÖZELLİKLER

Pompa:

- Pompa Gövdesi: AISI 304 Çelik
- Kademe Gömleği: AISI 304 Çelik
- Çark, Difüzör: AISI 304 Çelik
- Pompa Mil: AISI 304 Çelik
- Mekanik Salmastra sızdırmazlık (Karbon/Seramik/Viton)
- Çok Sesiz çalışma, düşük sarfiyat.
- Sıvı sıcaklığı: +5 °C ~ +90 °C
- Kollektör: AISI304 Çelik
- Şase: Çelik Sac (Titreşim önleyici kauçuk ayaklı)
- Susuz Çalışma Önleyici Seviye Flatörü
- Monometre ve Basınç Şalterli.
- Çek-Valf: Yaylı, sessiz
- Vana: Küresel (Bir Pompalı Hidroforlarda opsiyonel)

Pano:

- Motor & Faz Koruma Rölesi,
- Termik Manyetik Şalter,
- Kumanda Sigortası Donanımı
- Sıralı Çalıştırma Sistemi (Eş yaşlandırma)
- Susuz çalışma önleyici
- İkaz Ledleri (Susuz - Voltaj - Faz - Çalışma-Arıza)

KULLANIM ALANLARI

- Apartmanlar, siteler
- Okul, iş ve alışveriş merkezleri
- Sosyal tesisler
- Yangın söndürme sistemleri
- Su dağıtım istasyonları
- Filtre sistemleri (Ters ozmoz)

Not:

- Emiş Yapan Hidroforlarda Emiş Kollektörü kullanılmaz. Her Pompaya ayrı emiş borusu ve dip klapesi olmalıdır.
- Motorlarınızın sorunsuz çalışabilmesi ancak Motor Koruma Sistemli Panoların kullanımı ile mümkündür.

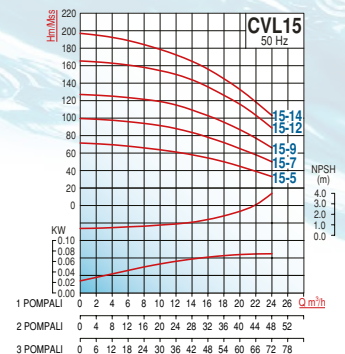
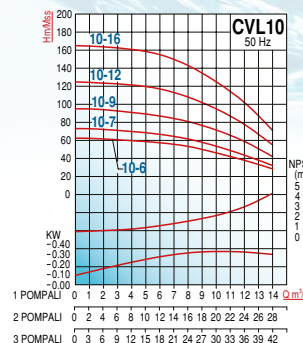
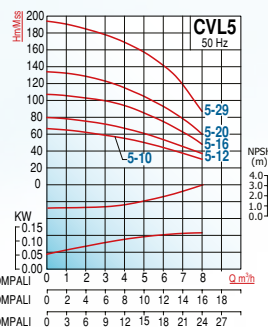
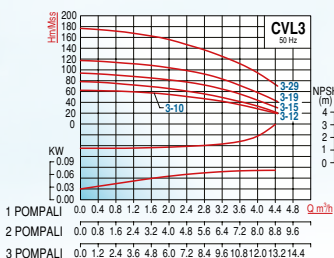
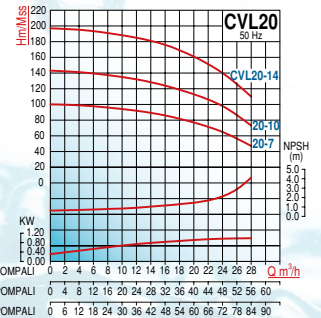

CVL

PAKET HİDROFORLAR (Tank ve Bağlantı Hortumu Hariçtir)

PACKAGED BOOSTER SETS (Excluding pressure tank and flexible hose)

ÜÇ POMPALI HİDROFORLAR / THREE-PUMP BOOSTER SETS

TİP TYPE	MOTOR		KADEME STAGE	KOLLEKTÖR		m ³ /h	DEBİ (Q) - CAPACITY					
	HP	kW		Giriş Inlet	Çıkış Outlet		3	6	7,5	9	10,5	12
CVL3-10x3 HİD.	1	0,75	10	2"	2"	Hm	60	55	50	43	36	28
CVL3-12x3 HİD.	1,5	1,1	12				72	66	59	52	44	34
CVL3-15x3 HİD.	1,5	1,1	15				90	82	77	69	60	44
CVL3-19x3 HİD.	2	1,5	19				113	104	98	88	77	58
CVL3-29x3 HİD.	3	2,2	29				156	147	132	118	93	
							6	9	12	15	19,5	24
CVL5-10x3 HİD.	2	1,5	10	2.5"	2.5"	Hm	62	59	55	50	41	30
CVL5-12x3 HİD.	3	2,2	12				75	73	68	62	49	36
CVL5-16x3 HİD.	3	2,2	16				103	100	94	85	69	48
CVL5-20x3 HİD.	4	3	20				129	122	115	105	86	60
CVL5-29x3 HİD.	5,5	4	29				185	177	168	157	132	87
							6	18	24	30	36	42
CVL10-6x3 HİD.	3	2,2	6	3"	3"	Hm	62	58	53	46	38	28
CVL10-7x3 HİD.	4	3	7				73	67	61	54	43	32
CVL10-9x3 HİD.	4	3	9				93	87	81	71	59	42
CVL10-12x3 HİD.	5,5	4	12				123	117	108	95	78	55
CVL10-16x3 HİD.	7,5	5,5	16				163	154	143	125	102	71
							24	36	45	54	60	72
CVL15-5x3 HİD.	5,5	4	5	3"	3"	Hm	68	61	56	50	45	33
CVL15-7x3 HİD.	7,5	5,5	7				94	88	80	71	64	50
CVL15-9x3 HİD.	10	7,5	9				122	115	106	95	87	66
CVL15-12x3 HİD.	15	11	12				158	150	140	126	116	89
CVL15-14x3 HİD.	15	11	14				183	172	162	145	133	103
							24	36	48	60	72	84
CVL20-5x3 HİD.	7,5	5,5	5	4"	4"	Hm	68	65	61	55	46	33
CVL20-7x3 HİD.	10	7,5	7				96	92	86	77	65	47
CVL20-10x3 HİD.	15	11	10				137	132	124	112	98	73
CVL20-14x3 HİD.	20	15	14				191	186	176	161	140	110



TEKNİK ÖZELLİKLER

Pompa:

- Pompa Gövdesi: AISI 304 Çelik
- Kademe Gömleği: AISI 304 Çelik
- Çark, Difüzör: AISI 304 Çelik
- Pompa Mili: AISI 304 Çelik
- Mekanik Salmastra sızdırmazlık (Karbon/Seramik/Viton)
- Çok Sesiz çalışma, düşük sarfiyat.
- Sıvı sıcaklığı: +5 °C ~ +90 °C
- Kollektör: AISI304 Çelik
- Şase: Çelik Sac (Titreşim önleyici kauçuk ayaklı)
- Susuz Çalışma Önleyici Seviye Flatörü
- Monometre ve Basınç Şalterli.
- Çek-Valf: Yaylı, sessiz
- Vana: Küresel (Bir Pompalı Hidroforlarda opsiyonel)

Pano:

- Motor & Faz Koruma Rölesi,
- Termik Manyetik Şalter,
- Kumanda Sigortası Donanımlı
- Sıralı Çalıştırma Sistemi (Eş yaşlandırma)
- Susuz çalışma önleyici
- İkaz Ledleri (Susuz - Voltaj - Faz - Çalışma-Arız)

KULLANIM ALANLARI

- Apartmanlar, siteler
- Okul, iş ve alışveriş merkezleri
- Sosyal tesisler
- Yangın söndürme sistemleri
- Su dağıtım istasyonları
- Filtre sistemleri (Ters ozmoz)

Not:

- Emiş Yapan Hidroforlarda Emiş Kollektörü Kullanılmaz. Her Pompaya ayrı emiş borusu ve dip klapesi olmalıdır.
- Motorlarınızın sorunsuz çalışabilmesi ancak Motor Koruma Sistemli Panoların kullanımı ile mümkündür.

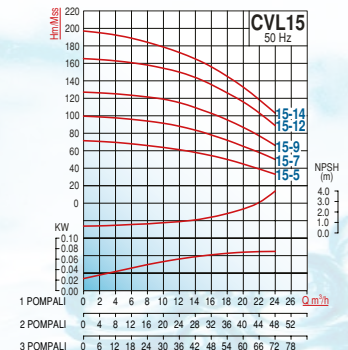
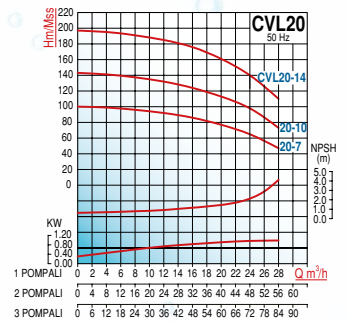
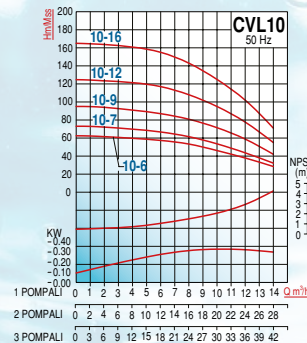
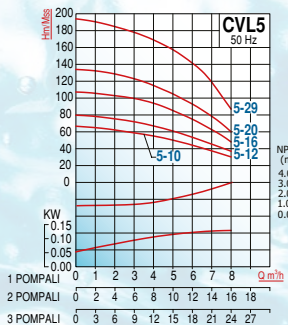
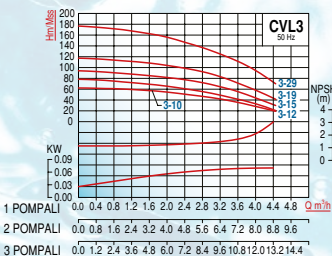

CVF

PAKET HİDROFORLAR (Tank ve Bağlantı Hortumu Hariçtir)

PACKAGED BOOSTER SETS (Excluding pressure tank and flexible hose)

BİR POMPALI HİDROFORLAR / TWO-PUMP BOOSTER SETS

TİP TYPE	MOTOR		KADEME STAGE	KOLLEKTÖR		m ³ /h	DEBİ (Q) - CAPACITY					
	HP	kW		Giriş Inlet	Çıkış Outlet		12	20	24	30	36	40
CV32-4x1 HİD.	10	7,5	4	2½"	2½"	Hm	72	66	62	53	42	34
CVF32-5x1 HİD.	15	11	5				91	83	78	66	53	42
CVF32-6x1 HİD.	15	11	6				109	101	95	83	65	52
CVF32-8x1 HİD.	20	15	8				143	134	126	111	88	70
CVF32-10x1 HİD.	25	18,5	10				179	169	162	142	114	88
CVF32-12x1 HİD.	30	22	12				214	203	194	171	137	107
CV45-3x1 HİD	15	11	3	3"	3"	Hm	25	30	35	45	50	55
CV45-4x1 HİD.	20	15	4				72	70	67	58	53	45
CVF45-5x1 HİD.	25	18,5	5				98	94	87	77	70	61
CVF45-6x1 HİD.	30	22	6				123	118	112	97	88	77
CVF45-9-2x1 HİD.	40	30	9				147	141	135	118	107	94
							209	202	193	169	152	133
CV64-3-1x1 HİD.	20	15,0	3	4"	4"	Hm	30	40	50	64	70	80
CVF64-4-2x1 HİD.	25	18,5	4				73	69	63	53	48	39
CVF64-4x1 HİD.	30	22	4				92	87	80	66	60	49
CVF64-6-2x1 HİD.	40	30	6				107	101	94	80	74	61
				147	140	130	112	101	81			
CVF90-2x1 HİD.	20	15,0	2	4"	4"	Hm	50	70	80	90	100	110
CVF90-3-2x1 HİD.	25	18,5	3				56	49	45	40	35	30
CVF90-3x1 HİD.	30	22	3				68	60	55	49	41	33
CVF90-4-2x1 HİD.	40	30	4				83	73	67	61	54	47
				98	87	80	72	62	50			



TEKNİK ÖZELLİKLER

Pompa:

- Pompa Gövdesi: AISI 304 Döküm Çelik
- Kademe Gömleği: AISI 304 Çelik
- Çark, Difüzör: AISI 304 Çelik
- Pompa Mili: AISI 304 Çelik
- Mekanik Salmastra sızdırmazlık (Karbon/Seramik/Viton)
- Çok Sesiz çalışma, düşük sarfiyat.
- Sıvı sıcaklığı: +5 °C ~ +90 °C
- Çelik Çek-Valf ve Vana donanımı (Opsiyonel)
- Şase: Çelik Sac (Titreşim önleyici kauçuk ayaklı)
- Susuz Çalışma Öncüleri Seviye Flatörü
- Monometre ve Basınç Şalterli.
- Çek-Valf: Yaylı, sessiz
- Vana: Küresel (Bir Pompalı Hidroforlarda opsiyonel)

Pano:

- Motor & Faz Koruma Rölesi,
- Termik Manyetik Şalter,
- Kumanda Sigortası Donanımlı
- Sıralı Çalıştırma Sistemi (Eş Yaşlandırma)
- Susuz çalışma önleyici
- İkaz Ledleri (Susuz - Voltaj - Faz - Çalışma-Arıza)

KULLANIM ALANLARI

- Apartmanlar, siteler
- Okul, iş ve alışveriş merkezleri
- Sosyal tesisler
- Yangın söndürme sistemleri
- Su dağıtım istasyonları
- Filtre sistemleri (Ters ozmoz)

Not:

- Emiş Yapan Hidroforlarda Emiş Kollektörü Kullanılmaz. Her Pompaya ayrı emiş borusu ve dip klapesi olmalıdır.
- Motorlarının sorunsuz çalışabilmesi ancak Motor Koruma Sistemli Pano kullanımı ile mümkündür.

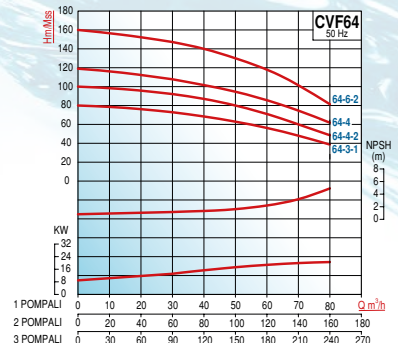
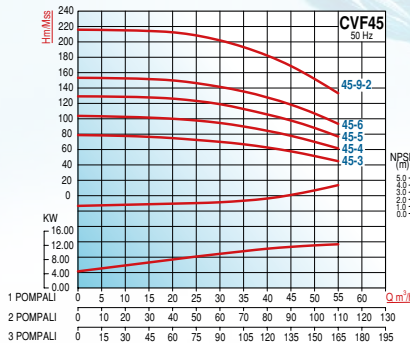
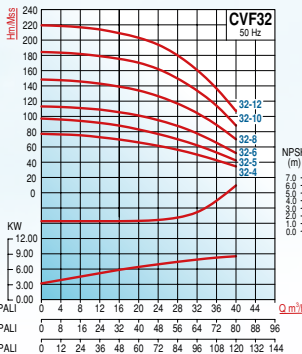
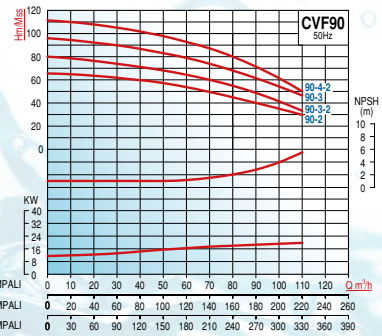

CVF

PAKET HİDROFORLAR (Tank ve Bağlantı Hortumu Hariçtir)

PACKAGED BOOSTER SETS (Excluding pressure tank and flexible hose)

İKİ POMPALI HİDROFORLAR / TWO-PUMP BOOSTER SETS

TİP TYPE	MOTOR		KADEME STAGE	KOLLEKTÖR		m ³ /h	DEBİ (Q) - CAPACITY					
	HP	kW		Giriş Inlet	Çıkış Outlet		24	40	48	60	72	80
CV32-4x2 HİD.	10	7,5	4	3"	3"	Hm	72	66	62	53	42	34
CVF32-5x2 HİD.	15	11	5				91	83	78	66	53	42
CVF32-6x2 HİD.	15	11	6				109	101	95	83	65	52
CVF32-8x2 HİD.	20	15	8				143	134	126	111	88	70
CVF32-10x2 HİD.	25	18,5	10				179	169	162	142	114	88
CVF32-12x2 HİD.	30	22	12				214	203	194	171	137	107
CV45-3x2 HİD	15	11	3	4"	4"	Hm	50	60	70	90	100	110
CV45-4x2 HİD.	20	15	4				72	70	67	58	53	45
CVF45-5x2 HİD.	25	18,5	5				98	94	87	77	70	61
CVF45-6x2 HİD.	30	22	6				123	118	112	97	88	77
CVF45-9-2x2 HİD.	40	30	9				147	141	135	118	107	94
CV64-3-1x2 HİD.	20	15,0	3	5"	5"	Hm	60	80	100	128	140	160
CVF64-4-2x2 HİD.	25	18,5	4				73	69	63	53	48	39
CVF64-4x2 HİD.	30	22	4				92	87	80	66	60	49
CVF64-6-2x2 HİD.	40	30	6				107	101	94	80	74	61
CVF90-2x2 HİD.	20	15,0	2	5"	5"	Hm	100	140	160	180	200	220
CVF90-3-2x2 HİD.	25	18,5	3				56	49	45	40	35	30
CVF90-3x2 HİD.	30	22	3				68	60	55	49	41	33
CVF90-4-2x2 HİD.	40	30	4				83	73	67	61	54	47
							98	87	80	72	62	50



TEKNİK ÖZELLİKLER

Pompa:

- Pompa Gövdesi: AISI 304 Döküm Çelik
- Kademe Gömleği: AISI 304 Çelik
- Çark, Difüzör: AISI 304 Çelik
- Pompa Mili: AISI 304 Çelik
- Mekanik Salmastra sızdırmazlık (Karbon/Seramik/Viton)
- Çok Sesiz çalışma, düşük sarfiyat.
- Sıvı sıcaklığı: +5 °C ~ +90 °C
- Çelik Çek-Valf ve Vana donanımı (Opsiyonel)
- Şase: Çelik Sac (Titreşim önleyici kauçuk ayaklı)
- Susuz Çalışma Önleyici Seviye Flatörü
- Monometre ve Basınç Şalterli.
- Çek-Valf: Yaıylı, sessiz
- Vana: Küresel (Bir Pompalı Hidroforlarda opsiyonel)

Pano:

- Motor & Faz Koruma Rölesi,
- Termik Manyetik Şalter,
- Kumanda Sigortası Donanımlı
- Sıralı Çalıştırma Sistemi (Eş Yaşlandırma)
- Susuz çalışma önleyici
- İkiz Ledleri (Susuz - Voltaj - Faz - Çalışma-Arıza)

KULLANIM ALANLARI

- Apartmanlar, siteler
- Okul, iş ve alışveriş merkezleri
- Sosyal tesisler
- Yangın söndürme sistemleri
- Su dağıtım istasyonları
- Filtre sistemleri (Ters ozmoz)

Not:

- Emiş Yapan Hidroforlarda Emiş Kollektörü Kullanılmaz. Her Pompaya ayrı emiş borusu ve dip klape olmalıdır.
- Motorlarının sorunsuz çalışabilmesi ancak Motor Koruma Sistemli Panoların kullanımı ile mümkündür.

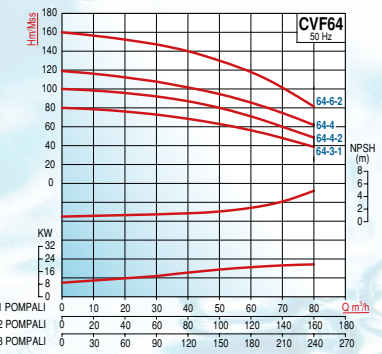
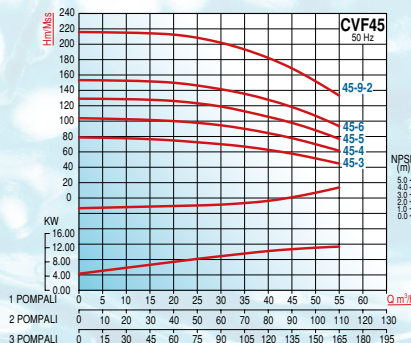
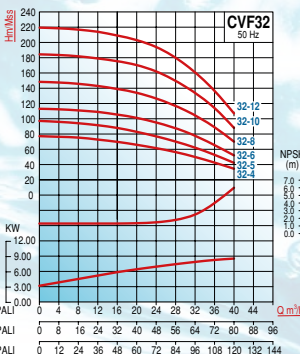
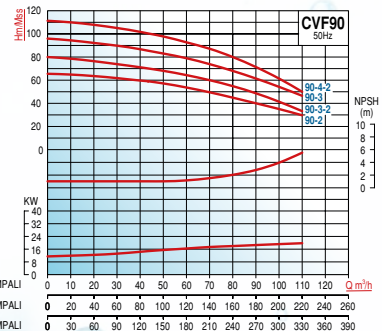

CVF

PAKET HİDROFORLAR (Tank ve Bağlantı Hortumu Hariçtir)

PACKAGED BOOSTER SETS (Excluding pressure tank and flexible hose)

ÜÇ POMPALI HİDROFORLAR / THREE-PUMP BOOSTER SETS

TİP TYPE	MOTOR		KADEME STAGE	KOLLEKTÖR		m ³ /h	DEBİ (Q) - CAPACITY					
	HP	kW		Giriş Inlet	Çıkış Outlet		36	60	72	90	108	120
CV32-4x3 HİD.	10	7,5	4	4"	4"	Hm	72	66	62	53	42	34
CVF32-5x3 HİD.	15	11	5				91	83	78	66	53	42
CVF32-6x3 HİD.	15	11	6				109	101	95	83	65	52
CVF32-8x3 HİD.	20	15	8				143	134	126	111	88	70
CVF32-10x3 HİD.	25	18,5	10				179	169	162	142	114	88
CVF32-12x3 HİD.	30	22	12				214	203	194	171	137	107
							75	90	105	135	150	165
CV45-3x3 HİD.	15	11	3	5"	5"	Hm	72	70	67	58	53	45
CV45-4x3 HİD.	20	15	4				98	94	87	77	70	61
CVF45-5x3 HİD.	25	18,5	5				123	118	112	97	88	77
CVF45-6x3 HİD.	30	22	6				147	141	135	118	107	94
CVF45-9-2x3 HİD.	40	30	9				209	202	193	169	152	133
										90	120	150
CV64-3-1x3 HİD.	20	15,0	3	6"	6"	Hm	73	69	63	53	48	39
CVF64-4-2x3 HİD.	25	18,5	4				92	87	80	66	60	49
CVF64-4x3 HİD.	30	22	4				107	101	94	80	74	61
CVF64-6-2x3 HİD.	40	30	6				147	140	130	112	101	81
							150	210	240	270	300	330
CVF90-2x3 HİD.	20	15,0	2	6"	6"	Hm	56	49	45	40	35	30
CVF90-3-2x3 HİD.	25	18,5	3				68	60	55	49	41	33
CVF90-3x3 HİD.	30	22	3				83	73	67	61	54	47
CVF90-4-2x3 HİD.	40	30	4				98	87	80	72	62	50



TEKNİK ÖZELLİKLER

Pompa:

- Pompa Gövdesi: AISI 304 Döküm Çelik
- Kademe Gömleği: AISI 304 Çelik
- Çark, Difüzör: AISI 304 Çelik
- Pompa Mili: AISI 304 Çelik
- Mekanik Salmastra sızdırmazlık (Karbon/Seramik/Viton)
- Çok Sesiz çalışma, düşük sarfiyat.
- Sıvı sıcaklığı: +5 °C ~ +90 °C
- Çelik Çek-Valf ve Vana donanımı (Opsiyonel)
- Şase: Çelik Sac (Titreşim önleyici kauçuk ayaklı)
- Susuz Çalışma Önleyici Seviye Flatörü
- Monometre ve Basınç Şalterli.
- Çek-Valf: Yaylı, sessiz
- Vana: Küresel (Bir Pompalı Hidroforlarda opsiyonel)

Pano:

- Motor & Faz Koruma Rölesi,
- Termik Manyetik Şalter,
- Kumanda Sigortası Donanımlı
- Sıralı Çalıştırma Sistemi (Eş yaşlandırma)
- Susuz çalışma önleyici
- İkaz Ledleri (Susuz - Voltaj - Faz - Çalışma-Arıza)

KULLANIM ALANLARI

- Apartmanlar, siteler
- Okul, iş ve alışveriş merkezleri
- Sosyal tesisler
- Yangın söndürme sistemleri
- Su dağıtım istasyonları
- Filtre sistemleri (Ters ozmoz)

Not:

- Emiş Yapan Hidroforlarda Emiş Kollektörü Kullanılmaz. Her Pompaya ayrı emiş borusu ve dip klapesi olmalıdır.
- Motorlarınızın sorunsuz çalışabilmesi ancak Motor Koruma Sistemli Panoların kullanımı ile mümkündür.

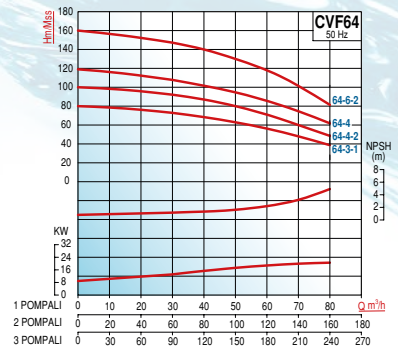
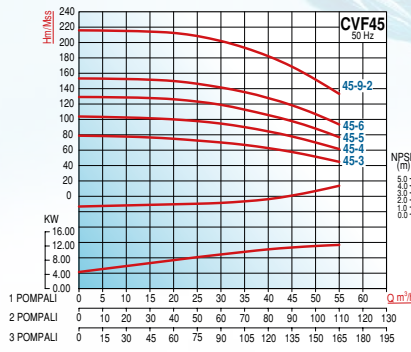
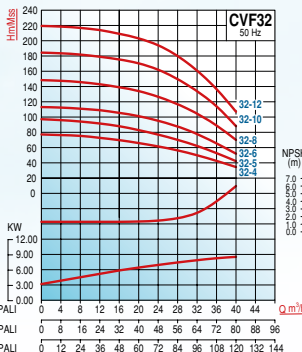
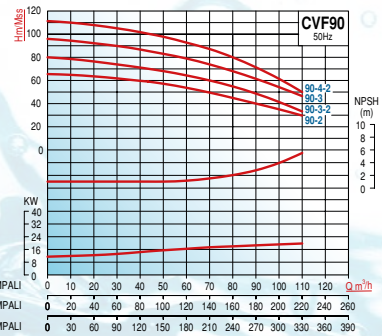

HİDROFOR TANKLARI (Membranlı)

TİP	AĞIZ	ÇALIŞMA BASINCI BAR	ÇAP (mm)	YÜKSEKLİK (mm)	AĞIRLIK (kg)
24 LT (KÜRE)	1"	6	350	380	3,6
50 LT (YATIK)		8	370	405	8,4
50 LT (DİKEY)		8	370	695	8,8
80 LT (YATIK)		8	460	490	13,6
100 LT (YATIK)		8	460	490	14,8
100 LT (DİKEY)		8	460	840	14,9
150 LT (DİKEY)		8	460	1120	26,2
200 LT (DİKEY)		10	600	1030	35,2
300 LT (DİKEY)	1 1/4"	10	640	1160	44,2
500 LT (DİKEY)		10	750	1430	69,4
750 LT (DİKEY)*		10	750	1920	86
1000 LT (DİKEY)*	2"	10	800	2120	153,4
1500 LT (DİKEY)*	2"	10	960	2430	267
2000 LT (DİKEY)*	2"	10	1100	2520	380

* İşaretti ürünler sadece fabrikamızdan teslim edilir.



FLEX HORTUM

BAĞLANTI	AÇIKLAMA
1"-1"	Paslanmaz Çelik örgü, 70 cm
1"-1"	Paslanmaz Çelik örgü, 80 cm
1"-1"	Paslanmaz Çelik örgü, 150 cm
1 1/4" - 1"	Paslanmaz Çelik örgü, 80 cm
1 1/4" - 1 1/4"	Paslanmaz Çelik örgü, 80cm
1 1/4" - 1 1/4"	Paslanmaz Çelik örgü, 150cm
2" - 2"	Paslanmaz Çelik örgü, 150 cm

NOT: 16 BAR VE ÜSTÜNE ÖNERİLMEZ



ELEKTRONİK HİDROFOR KİTLERİ

TİP TYPE	GİRİŞ	V	MAX AMP	MAX DEBİ	ÖZELLİK
	ÇIKIŞ				
PC-13A	1"	220	10 A	10 m ³ /h	Maximum 1 HP Pompalar içindir.



PC-13A

YANGIN POMPALARI ve HİDROFORLARI

FIRE FIGHTING PUMPS AND BOOSTER SYSTEMS

YANGIN POMPALARI

NFPA 20'ye uygun pompa özellikleri

- Her pompa için ayrı kumanda panosu kullanılır.
- Anma debisinde, emme borusundaki akış hızı 3 m/sn den küçük olacak şekilde boru sistemi tasarlanmalıdır.
- Sıfır debide max. basınç anma basıncının %140'ından fazla olmamalıdır.
- Pompa anma debisinin 1.5 katı değerinde basınç, anma değerinin %65'inden az olamaz.
- Debi, %150 olduğunda basınç, anma değerinin %65 altına düşmez
- Elektrik motorlarının servis faktörü (aşırı yüklenebilme çarpanı) 1.15'i geçmemelidir.
- Yataklama: Rulmanın ömrü en az 5000 saat
- Pompa çarkı: Bronz
- Pompa mili: AISI 316 veya AISI 304
- Pompa gövdesi: GG 25 Pik döküm
- Sızdırmazlık: 5 kat yumuşak salmastra
- Flanş: DIN 2533 PN16



Pompa ekipmanları

- Girişte ve Çıkışta basınç göstergeleri (monometre, vakummetre)
- Otomatik hava tahliye vanası
- Esnek kaplin
- Donmaya karşı sızdırma vanası
- Gövde soğutma vanası (casing relief valve)
- Hız düşürücü ekipmanlar

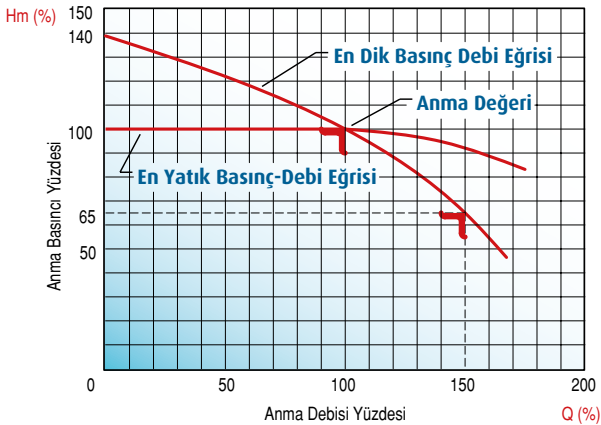

Yangın Hidroforları

(Elektrik ve Dizel Motorlu)

Fire Fighting Booster Sets

(Electric Motor ve Diesel Engine)

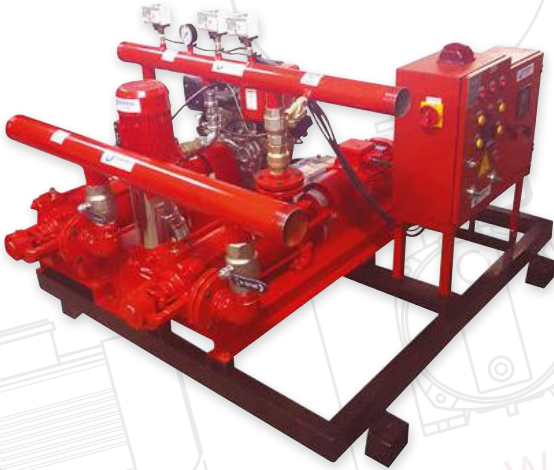

TEKNİK ÖZELLİKLER

Elektrikli gruplarda 30 - 130 mSS anma basıncı aralığında 5.7 m³/h - 340 m³/h (25 - 1500 gpm) anma debilerini sağlamaktadır. Kendini test edebilme özellikli panolu, jokey pompalı ve ışık-ses alarm donanımlı imal edilmektedir.

TECHNICAL DATA

These type of electrical fire fighting boosters have 5.7 - 340 m³/h (25 - 1500 gpm) capacity range at 30 - 130 m head range. These boosters are produced with Jokey Pump and Control panel (automatic-test function and fire alarm siren integrated.)

PVM

SERİSİ YANGIN HİDROFORLARI (Test Programlı, Siren-Işık Alarmlı)

SERIES FIRE FIGHTING BOOSTERS (Auto-Test Function and Fire Alarm equipped)

BİR POMPALI HİDROFORLAR / SINGLE-PUMP BOOSTER SETS

TİP TYPE	MOTOR (HP)	POMPA MODELİ	KADEME STAGE	KOLLEKTÖR GirişÇıkış InletxOutlet	m ³ /h	DEBİ (Q) - CAPACITY						
						1	4	6	12	18	24	
PVM4-4x1 Y.HİD.	1.5	VM4-4	4	2"	Basınç (Bar)	5,3	4,9	4,5	2			
PVM2-7x1 Y.HİD.	1.5	VM2-7	7			8	6,5	4,5				
PVM2-9x1 Y.HİD.	2	VM2-9	9			10,8	8	5,5				
PVM4-6x1 Y.HİD.	2	VM4-6	6			8	7,5	6,8	3,5			
PVM4-8x1 Y.HİD.	3	VM4-8	8			10,5	9,5	8,6	4,5			
PVM12-6x1 Y.HİD.	4	VM12-6	6			6,6	6,3	6	5,2	4	2,5	
PVM12-8x1 Y. HİD.	6,3	VM 12-8	8			8,7	8,5	7,7	6,6	4,2	3	
PVM14-4x1 Y.HİD.	4	VM14-4	4			7,8	7,7	7,1	6,1	4,6	2,9	
PVM14-5x1 Y.HİD.	5,5	VM14-5	5			9,7	9,4	9	7,2	5,2	3,4	
PVM14-7x1 Y.HİD.	7,5	VM14-7	7			12,7	12,2	11,6	9,1	6,7	4,2	



İKİ POMPALI HİDROFORLAR / TWO-PUMP BOOSTER SETS

TİP TYPE	MOTOR (HP)	POMPA MODELİ	KADEME STAGE	KOLLEK. GirişÇıkış InletxOutlet	m ³ /h	DEBİ (Q) - CAPACITY						
						2	8	12	24	36	48	
PVM4-4x2 Y.HİD.	1.5	VM4-4	4	2.5" x 2"	Basınç (Bar)	5,3	4,9	4,5	2			
PVM2-7x2 Y.HİD.	1.5	VM2-7	7			8	6,5	4,5				
PVM2-9x2 Y.HİD.	2	VM2-9	9			10,8	8	5,5				
PVM4-6x2 Y.HİD.	2	VM4-6	6			8	7,5	6,8	3,5			
PVM4-8x2 Y.HİD.	3	VM4-8	8			10,5	9,5	8,6	4,5			
PVM12-6x2 Y.HİD.	4	VM12-6	6			6,6	6,3	6	5,2	4	2,5	
PVM12-8x2 Y.HİD.	6,3	VM 12-8	8			8,7	8,5	7,7	6,6	4,2	3	
PVM14-4x2 Y.HİD.	4	VM14-4	4			7,8	7,7	7,1	6,1	4,6	2,9	
PVM14-5x2 Y.HİD.	5,5	VM14-5	5			9,7	9,4	9	7,2	5,2	3,4	
PVM14-7x2 Y.HİD.	7,5	VM14-7	7			12,7	12,2	11,6	9,1	6,7	4,2	



ÜÇ POMPALI HİDROFORLAR / THREE-PUMP BOOSTER SETS

TİP TYPE	MOTOR (HP)	POMPA MODELİ	KADEME STAGE	KOLLEK. GirişÇıkış InletxOutlet	m ³ /h	DEBİ (Q) - CAPACITY						
						3	12	18	36	54	72	
PVM4-4x3 Y.HİD.	1.5	VM4-4	4	2" x 2" veya 3" x 3"	Basınç (Bar)	5,3	4,9	4,5	2			
PVM2-7x3 Y.HİD.	1.5	VM2-7	7			8	6,5	4,5				
PVM2-9x3 Y.HİD.	2	VM2-9	9			10,8	8	5,5				
PVM4-6x3 Y.HİD.	2	VM4-6	6			8	7,5	6,8	3,5			
PVM4-8x3 Y.HİD.	3	VM4-8	8			10,5	9,5	8,6	4,5			
PVM12-6x3 Y.HİD.	4	VM12-6	6			6,6	6,3	6	5,2	4	2,5	
PVM12-8x2 Y.HİD.	6,3	VM 12-8	8			8,7	8,5	7,7	6,6	4,2	3	
PVM14-4x3 Y.HİD.	4	VM14-4	5			7,8	7,7	7,1	6,1	4,6	2,9	
PVM14-5x3 Y.HİD.	5,5	VM14-5	5			9,7	9,4	9	7,2	5,2	3,4	
PVM14-7x3 Y.HİD.	7,5	VM14-7	7			12,7	12,2	11,6	9,1	6,7	4,2	

*HİDROFOR TANKI VE BAĞLANTI FLEKS HORTUMU HARIÇTİR.
-(*) 10 Bar üzeri sistemler 16 Bar'lık Tank ile kullanılmalıdır.

TEKNİK ÖZELLİKLER

Pano:

- Haftalık Test Programlı (Selonoid Valf Kontrollü)
- Siren-Işık Alarmlı
- Dijital Ayar Ekranı,
- Faz Gerilim Koruma özelliği,
- Motor Koruma (Ampermetrik)
- Yüksek Akıma Karşı Hassas Motor Koruma,
- Akım & Gerilim vs Değerlerin Ayarlanabildiği Menü Butonları
- Voltmetre & Ampermetre & Pompa Çalışma Süreleri, Koruma Gecikme Süreleri (Dijital Göstergeli)
- Sistem İkaz Ledleri (Susuz - Voltaj - Faz - Çalışma-Arıza)
- Sıralı veya Süreli Çalıştırma Yöntemi ile Eş Yaşlandırma
- Her Pompa için Otomatik - Manuel Test Butonu,

Pompa:

- Emiş & Basış Gövdesi: GG-25 PİK
- Kademe Gömleği: AISI 304 Çelik
- Çark , Difüzör Noryl (PPO)
- Pompa Mili AISI 304
- Sızdırmazlık: Mekanik Salmastra(Karbon/Seramik/NBR)
- Emiş ve Basış Kollektörü Dahil (Bir Pompalı Hidroforlarda Opsiyonel) (AISİ 304 Çelik, 2" üzeri Demir Kollektör)
- Solenoid Valf (Çıkış Kollektörü Üzerinde)
- Çek-Valf: Yaylı, sessiz
- Vana: Küresel (Bir Pompalı Hidroforlarda opsiyonel)
- Şasi: Çelik sac(Titreşim önleyici kauçuk ayaklı)
- Manometre ve Basınç Şalterli.

KULLANIM ALANLARI

- Apartmanlar, siteler
- Okul, iş ve alışveriş merkezleri
- Sosyal tesisler

Not:

Emiş Yapan Hidroforlarda Emiş Kollektörü Kullanılmaz.
Her Pompaya ayrı emiş borusu ve dip klapesi olmalıdır.

SU BORULARINDAKİ SÜRTÜNME KAYBI HESAP CETVELİ

PLASTİK BORU DIŞ ÇAPI	25	32	40	50	63	75	90	110	140	160	200	225	280		
PLASTİK BORU ANMA ÇAPI	20	25	32	40	50	65	80	100	125	150	175	200	250		
METAL SU BORULARI	3/4"	1"	1"1/4"	1"1/2"	2"	2"1/2"	3"	4"	5"	6"	7"	8"	10"		
m ³ /h	l/min	l/s	DÜZ DÖKÜM BORULARIN HER 100 METRESİNDEKİ SÜRTÜNME KAYBI (metre)												
1,2	20	0,3	10,4	3,7	1	0,3									
1,5	25	0,4	15,8	5,7	1,5	0,5									
1,8	30	0,5	22,3	8	2,1	0,7									
2,1	35	0,6	29,8	10,8	2,8	0,9	0,3		PVC boru için çarpan				0,65		
2,4	40	0,7	38,2	13,8	2,7	1,2	0,4		Alüminyum boru için çarpan				0,70		
3	50	0,8	58,2	21,1	8	1,8	0,6		Yeni çelik boru için çarpan				0,80		
3,6	60	1	82	30	10,8	2,5	0,9		Az paslı çelik boru için çarpan				1,25		
4,2	70	1,2		40	13,9	3,3	1,1								
4,8	80	1,3		51,5	17,5	4,3	1,5								
5,4	90	1,5		64	21,4	5,4	1,8	0,5							
6	100	1,7		79	33	6,6	2,2	0,6							
7,5	125	2,1			47	10	3,4	0,9							
9	150	2,5			63	14,2	4,7	1,2	0,4						
10,5	175	2,9			82	19	6,3	1,6	0,6						
12	200	3,3				24,5	8,1	2,1	0,7						
15	250	4,2				37,5	12,3	3,2	1,1	0,4					
18	300	5				53	17,3	4,5	1,6	0,5					
24	400	6,7					29,5	7,8	2,7	0,9					
30	500	8,3					44,8	12	4,1	1,4	0,5				
36	600	10						16,9	5,8	1,9	0,7				
42	700	11,7						22,6	7,8	2,6	0,9				
48	800	13,3						29	10	3,4	1,2	0,4			
54	900	15						36	12,5	4,2	1,5	0,5			
60	1000	16,7							15,2	5,1	1,8	0,7			
75	1250	20,8							23	7,9	2,7	1	0,5		
90	1500	25							32,6	11,2	3,8	1,4	0,7		
105	1750	29,2								15	5	1,9	0,9	0,5	
120	2000	33,3								19,4	6,5	2,4	1,2	0,6	
150	2500	41,7								30	9,8	3,8	1,8	0,9	
180	3000	50									13,8	5,3	2,5	1,3	
240	4000	66,7									23,8	9,1	4,4	2,2	0,7
300	5000	83,3										13,9	6,6	3,3	1,1
360	6000	100										20	9,5	4,7	1,6
420	7000	116,7											12,8	6,4	2,1
480	8000	133,3											21	10,5	3,5

KAT VE DAİRE SAYISINA GÖRE PRATİK HİDROFOR SEÇİM TABLOSU

KAT SAYISINA GÖRE BASINÇ TAYİNİ

Kat Sayısı	Basınç (bar)
1	2.4
2	2.8
3	3.1
4	3.5
5	3.8
6	4.1
7	4.5
8	4.8
9	5.2
10	5.5
11	5.9
12	6.2
13	6.6
14	6.9
15	7.3
16	7.6
17	7.9
18	8.3
19	8.6
20	9
21	9.3
22	9.7
23	10
24	10.4
25	10.7
26	11.5
27	11.4
28	11.7
29	12.1
30	12.4

DAİRE SAYISINA GÖRE DEBİ TAYİNİ

Daire Sayısı	Q (m ³ /h)	Daire Sayısı	Q (m ³ /h)
1	0.4	31	6.5
2	0.8	32	6.7
3	1.2	33	6.9
4	1.6	34	7.2
5	1.2	35	7.4
6	1.44	36	7.6
7	1.7	37	7.8
8	2	38	8
9	2.2	39	8.2
10	2.4	40	8.4
11	2.3	41	8.6
12	2.5	42	8.8
13	2.7	43	9
14	2.9	44	9.3
15	3.2	45	9.5
16	3.4	46	9.7
17	3.6	47	9.9
18	3.8	48	10.1
19	4	49	10.3
20	4.2	50	10.5
21	4.4	51	10.7
22	4.6	52	10.9
23	4.8	53	11.1
24	5	54	11.3
25	5.3	55	11.6
26	5.5	56	11.8
27	5.7	57	12
28	5.9	58	12.2
29	6.1	59	12.4
30	6.3	60	12.6

UYGUN HİDROFORUN SEÇİLMESİ İÇİN BİLİNMESİ GEREKENLER

- 1- Birden çok kullanıcının aynı sistemden faydalandığı, kullanım miktarının günün değişik zaman dilimlerine göre değiştiği uygulamalarda, toplam hesap edilen debi gereksiniminin birden çok pompa ile karşılanması daha doğrudur. Örneğin hesap edilen toplam debi gereksinimi 30 m³/h ise burada tek pompalı hidrofor sistemi seçimi yerine beheri 15 m³/h kapasiteli 2 pompalı veya beheri 10 m³/h kapasiteli 3 pompalı sistemler tercih edilmelidir.
- 2- Pompalardan birinin arızasından dolayı devre dışı kalması gibi durumunda eğer yedek pompa bulunması arzu ediliyor ise sistemi oluşturan pompaların her birinin debisindeki başka bir pompa kullanılmalıdır. Örneğin böyle bir durumda toplam debi gereksinimi 30 m³/h ise, beheri 30 m³/h kapasiteli 2 pompalı bir sistem veya beheri 15 m³/h kapasiteli 3 pompalı bir sistem kurulmalıdır.
- 3- Seçilen pompaların istenen debide çalışacağı alt ve üst basınç noktaları pompa eğrisinin verimli noktasına yakın olmalıdır.
- 4- Hidroforda kullanılan pompaların emiş yapacağı depo veya rezerv, pompa montaj seviyesinden aşağıda ise sipariş esnasında bu konu mutlaka belirtilmelidir.
- 5- Eğer pompalanacak suda fiziksel ve kimyasal aşındırıcılar bulunuyor ise sipariş esnasında bu durum mutlaka bildirilmelidir.

Tablo-1

Örnek Mekanlar İçin Kişi Başına Su Tüketimi	
Yerleşim Tipi	Kişi Başına Günlük Tüketim (lt/kişi)
Konut (lavabolu)	60 - 80
Konut (Duşlu)	80 - 115
Konut (Küvetli)	120 - 200
Otel (Duşlu)	100
Otel (Küvetli)	150 - 200
Hastane	200 - 500
Okul	5
Çocuk Yuvası	80 - 100
Kreş	100 - 150
Kışla	60 - 80
Lokanta	10 - 20
Bahçe Sulama	1,5 lt/m ² bir seferde
Araba Yıkama	100 lt/gün

Tablo-2

Kişi Başına Su Tüketimi İçin Çarpma Faktörü	
Yerleşim Tipi	(K) Faktörü
Konutlar (1 - 5 daire)	0,66
Konutlar (6 - 10 daire)	0,45
Konutlar (11 - 20 daire)	0,40
Konutlar (21 - 50 daire)	0,35
Konutlar (51 - 100 daire)	0,30
Konutlar (100 daire üstü)	0,25
Oteller (1 - 20 yataklı)	0,40
Oteller (21 - 50 yataklı)	0,40 - 0,30
Oteller (50 yatak üstü)	0,30 - 0,20
Hastaneler (50 - 500 yataklı)	0,30 - 0,20
Hastaneler (501 - 1000 Yataklı)	0,20 - 0,15
Hasaneler (1001 - 2000 Yataklı)	0,15 - 0,10
Okullar	0,30
Çocuk Yuvaları	0,40
Kışlalar	0,40 - 0,30
İş Hanları	0,30

UYGUN HİDROFOR SEÇİMİ

Yandaki tabolardaki daire sayısı ve kat adedi altında belirtilen değerler esas alınarak örnekler hesaplanmıştır. Ancak değişik kullanım amaçları ve yerleri için uygun hidrofor seçimi aşağıda açıklandığı şekilde yapılabilir.

GEREKLİ BASINCIN HESABI

$$H_{min} (mss) = h + hk + hc$$

h Hidroforun yerleştirildiği yer ile binanın su basılacak en üst noktası arasındaki kot farkı (mt) (Kat sayısı x Kat yüksekliği)

hk Tesisattaki vana, dirsek, su sayacı, boru vs. kayıpları toplamı (Bu değer genellikle toplam h yüksekliğinin % 20 si olarak alınır) (mt)

hc Binanın en üst seviyesinde olması istenen çıkış basıncıdır. Genellikle 10 - 15 mt arası alınır.

GEREKLİ DEBİNİN HESABI

$$Q_{min} (m^3/h) = \text{Daire Sayısı} \times \text{Dairedeki Kişi Sayısı} \times \text{Kişi başı günlük tüketim} \times K/1000$$

Kişi başı günlük tüketim: Tablo 1'den seçilir. (lt/gün)
K: Eş zamanlı faktörü (Tablo 2'den seçilir.)

Örnek Hesaplama

6 Kat, 21 daireli bir bina (konut) için basınç, debi tayini ve pompa seçimi:

$$h = 6 \text{ kat} \times 2,8 \text{ (tek kat yüksekliği)} = 16,8 \text{ mss}$$

$$hk = 0,2 \times h = 0,2 \times 16,8 = 3,4 \text{ mss}$$

$$hc = 10 \text{ mss}$$

$$H_{min} = h + hk + hc = 16,8 + 3,4 + 10 = 30,2 \text{ mss}$$

Daire Sayısı: 21

Dairedeki kişi sayısı: 5 kişi

Kişi başı günlük tüketim : 100 lt (Tablo 1)

Eş zamanlı kullanım fak. K:0,35 (Tablo 2)

$$\text{Debi, } Q = 21 \times 5 \times 100 \times 0,35 / 1000 = 3,7 \text{ m}^3/\text{saat}$$

- Hidrofora alt seviyeden emiş yaptırılmamalıdır. Depo hidroforun yanında veya üst seviyesinde olmalıdır.
- Pompaların su emişinde zorlanmalarını gerekir. Bu nedenle, hidrofor emiş çapları kesinlikle küçültülmemelidir.
- Tek pompalı hidroforlarda pompa su giriş çapı değerinden bir boy büyük, iki ve üç pompalı hidroforlarda ise emiş kollektörü çapında emiş tesisatı çekilmelidir.

KABLO SEÇİM CETVELİ

GERİLİM	MOTOR GÜCÜ		Kablo kesidi 4* mm											
	VOLTAJ	kW	Hp	1,5	2,5	4	6	10	16	25	35	50	70	95
220	0,37	0,55		80	130									
	0,55	0,75		55	90	140								
	0,75	1		40	80	105	160							
	1,1	1,5		30	50	75	115	190						
	1,5	2		20	35	60	90	145	235					
	2,2	3			30	50	70	120	185					
380	0,37	0,55		570										
	0,55	0,75		379										
	0,75	1		230										
	1,1	1,5		180	235									
	1,5	2		135	225	360								
	2,2	3		100	165	285	390							
	3	4		65	110	180	225	420						
	4	5,5		50	85	135	195	330	500					
	5,5	7,5		40	70	110	165	270	420					
	7,5	10			60	100	150	250	410					
	9	12,5			50	80	120	205	330	560				
11	15				60	160	170	280	440					
380 Yıldız Üçgen	16	20				80	110	260	310	490				
	18,5	25				60	90	160	250	400	450			
	22	30				50	70	130	210	340	470			
	26	35				45	65	110	180	290	410			
	30	40					60	100	160	250	360	500		
	37	50					40	80	130	200	290	410		
	45	60						70	110	170	240	350	450	
	55,5	75							80	130	180	260	360	500
	66	90								110	160	230	320	450
	75	100								100	140	200	250	330
	92	125									120	170	230	300

%3 Gerilim düşümü 25 C ortam sıcaklığı

Motor gücüne ve montaj derinliğine göre kablo çapının seçildiği tablo yukarıdadır.
 Daha büyük beygir gücündeki motorlar için firmamızla temas kurun.

İRTİFA (KOT FARKI) HESABI

EĞİM %	AÇI (a)	SİN a DEĞERİ
5%	3°	0,052
7%	4°	0,07
10%	6°	0,104
15%	8°	0,139
20%	11°	0,19
25%	14°	0,241
30%	17°	0,292
35%	19°	0,325
40%	22°	0,374
45%	24°	0,406
50%	27°	0,453
55%	29°	0,484
60%	31°	0,515
65%	33°	0,544
70%	35°	0,573
75%	37°	0,601

FORMÜL: İrtifa (Kot Farkı) = Sin a x Mesafe

ÖRNEK:

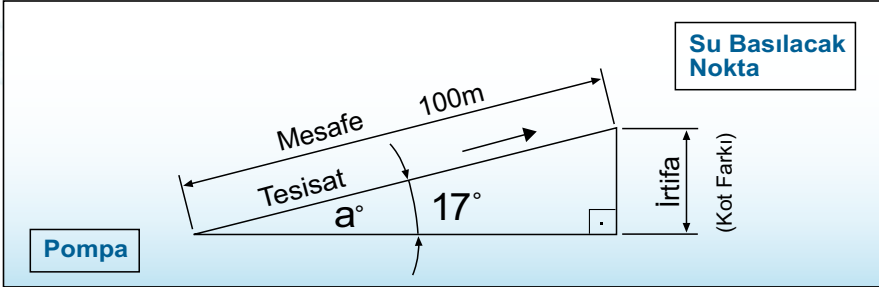

Mesafe= 100 m.

Eğim = %30

Tablodan => 17°

Tablodan => Sin 17°

=0,292

İrtifa (Kot Farkı) = 100 m. x 0.292 = 29.2 Metre

(Pompanın su basacağı noktanın irtifası 29.2 Metredir.)

Not: Akıllı telefonunuza yükleyebileceğiniz "Altimetre" uygulamalarıyla rakımı bulup kot farkı hesaplayabilirsiniz.

Sertifikalarımız

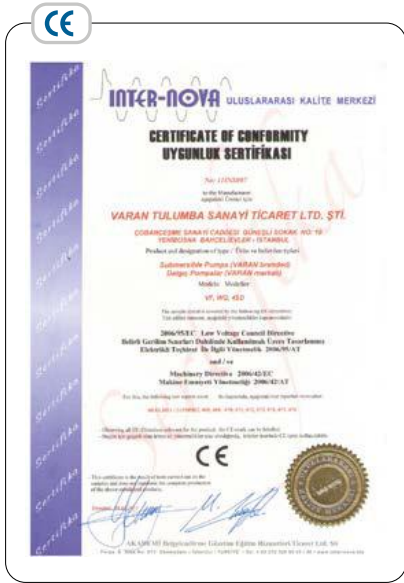

Sertifikalamızız

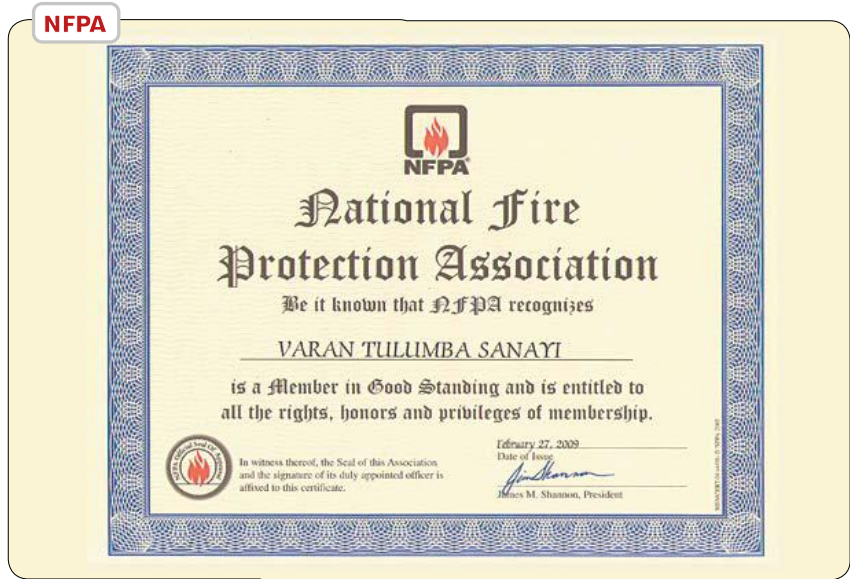

Fabrika ve Üretim Bölümleri



Fabrika ve Üretim Bölümleri





VARAN
POMPA



Whatsapp Destek Hattı
0533 930 34 85

VARAN Tulumba San. ve Tic. Ltd. Şti.

Çobançeşme Mah. Sanayi Cad. Çalışlar 1 Sok. No: 19
Yenibosna-Bahçelievler-İstanbul-TÜRKİYE

Tel : (+90 212) 551 15 30 - 652 60 54 - 503 25 20 - 552 74 55

Fax : (+90 212) 552 97 69

E-mail : varanpompa@varanpompa.com

www.varanpompa.com